

invenSYS
Eurotherm



P304i Process Indicator
User
Manual

HA031862/3
Date: July 2014

P304i Process Indicator
User Manual Part Number HA031862 Issue 3 Date July 2014

Contents

1. DESCRIPTION.....	3
1.1 Unpacking Your Indicator.....	3
1.2 Dimensions.....	3
1.3 Step 1: Installation.....	4
1.3.1 Panel Mounting the Indicator.....	4
1.3.2 Panel Cut Out Size	4
1.4 Order Code	5
1.5 Step 2: Wiring	6
1.5.1 Rear Terminal Connections	6
1.5.2 Block Diagram and Isolation Boundaries	6
1.5.3 Wire Sizes	6
1.5.4 Power Supply	7
1.5.5 Sensor Inputs	8
1.5.6 Transmitter Power Supply (TPSU).....	9
1.5.7 Analogue Outputs.....	10
1.5.8 'Reset' Digital Input.....	11
1.5.9 Alarms	12
1.5.10 Modbus Serial Communications	13
2. SAFETY AND EMC INFORMATION	14
3. SWITCH ON	15
3.1 Operator Display	15
3.1.1 Status Indication	15
3.1.2 Keyboard.....	15
3.1.3 Example - To Display Selected Parameters.....	15
3.2 Open Indication	16
3.3 Levels of Operation	16
3.4 Level 1 Operation	17
3.4.1 Level 1 Parameters.....	17
3.4.2 Example - To Set Alarm 1 Threshold	17
3.5 To Select Other Levels of Operation	17
3.6 Level 2 Operation	18
3.6.1 Level 2 Parameters.....	18
3.7 To Return to Level 1	18
3.8 Alarms	19
3.9 Definition of Alarm Types.....	19
3.9.1 Process High	19
3.9.2 Process Low.....	19
3.9.3 Alarm Mask at Start up	20
3.9.4 Alarm Mask Reset.....	20
3.9.5 Alarm Reset Mode.....	20
3.9.6 Alarm Acknowledgement.....	20
3.9.7 Failsafe mode.....	20
3.9.8 Threshold.....	20
3.9.9 Hysteresis.....	20
3.9.10 Alarm Filter	20
3.9.11 Behaviour of Alarms after a Power Cycle.....	20
3.10 Pressure Transducer Calibration	21
3.10.1 Calibration of a Pressure Transducer fitted with an internal shunt resistor.....	21
3.10.2 Calibration of a Pressure Transducer with an external shunt resistor	21
3.10.3 Calibration of an amplified pressure transducers with an internal shunt resistor	21
3.10.4 Calibration of pressure transducer connected to the secondary input	21
4. INDICATOR BLOCK DIAGRAM.....	22
5. CONFIGURATION LEVEL.....	23
5.1 To Select Configuration Level	23

5.2	Configuration Level Parameters	23
5.3	Configuration - 'P' Codes	24
5.3.1	Summary.....	24
5.3.2	Pressure Input Selection.....	25
5.3.3	Shunt Calibration.....	25
5.3.4	Pressure Input Display Update Time.....	25
5.3.5	Secondary Input.....	26
5.3.6	Main Analogue Output.....	27
5.3.7	Secondary Analogue Output.....	28
5.3.8	Alarms.....	29
5.3.9	Logic Input.....	30
5.3.10	Peak Detection.....	30
5.3.11	Line Frequency.....	30
5.3.12	Digital Communications.....	31
5.3.13	Pass codes.....	32
5.3.14	Recovery Point.....	32
6.	DIGITAL COMMUNICATIONS	33
6.1	EIA485 Field Communications Port.....	33
6.2	Modbus/JBus Protocol.....	33
7.	INSTRUMENT CALIBRATION	34
7.1	To Access Calibration Mode.....	34
7.2	Error Codes.....	36
7.3	Example 1: To Calibrate the Thermocouple Input.....	37
7.3.1	Connect a calibrated mV source to the thermocouple input terminals using copper cable.....	37
7.3.2	Connect a temperature calibrator to the thermocouple input terminals using compensating cable.....	38
7.4	Example 2: To Calibrate the Pt100 RTD Input.....	39
7.5	Example 3: To Calibrate the Pt500 RTD Input.....	40
7.6	Example 4: To Calibrate the 0-10V Main Input.....	41
7.7	Example 5: To Calibrate the 0-5V Main Input.....	42
7.8	Example 6: To Calibrate the 0-20mA Main Input.....	43
7.9	Example 7: To Calibrate the Main Voltage Output (OUT1).....	44
8.	CPI (CONFIGURATION PORT INTERFACE)	45
8.1	CPI Adaptor.....	45
8.2	Firmware Update Procedure.....	46
9.	APPENDIX A MODBUS AND JBUS ADDRESSES	47
9.1	Multiplier and Decimal figures.....	47
9.2	S2K IEEE floating point notation.....	47
9.3	Level 1 and Level 2 Parameters.....	47
9.4	Configuration Parameters.....	49
9.5	Other Parameters.....	52
10.	APPENDIX B TECHNICAL SPECIFICATION	53
11.	INDEX	56

Issue status of this Manual

Issue 2 makes minor corrections.

Issue 3 updates strain gauge wiring diagram.

1. Description

P304i is a microprocessor based ¼ DIN indicator of pressure and temperature based on the Piccolo range of instruments. It is suitable for use on a wide range of processes including the indication of extruder melt pressure and temperature.

Two process inputs are available which are user configurable for 350Ω strain gauges, voltage or current and a second input accepts a range thermocouples and RTDs for temperature measurement. A 24Vdc power supply provides the voltage for two or four wire transducers.

Two voltage or mA outputs may be configured for analogue retransmission of process measurements.

Three alarms may be attached to the measured variable to provide indication and interlocks of any out of tolerance condition.

EIA485 3-wire digital communications uses Modbus/Jbus communications.

Configuration and commissioning parameters may be set through the front panel keys (protected by different levels of access).

This manual describes installation, wiring, operation, configuration and calibration of the instrument.

1.1 Unpacking Your Indicator

The package contains:

- P304i indicator mounted in its sleeve
- 2 X Panel securing clips
- Installation sheets in English, French, German and Italian
- Panel sealing gasket

1.2 Dimensions

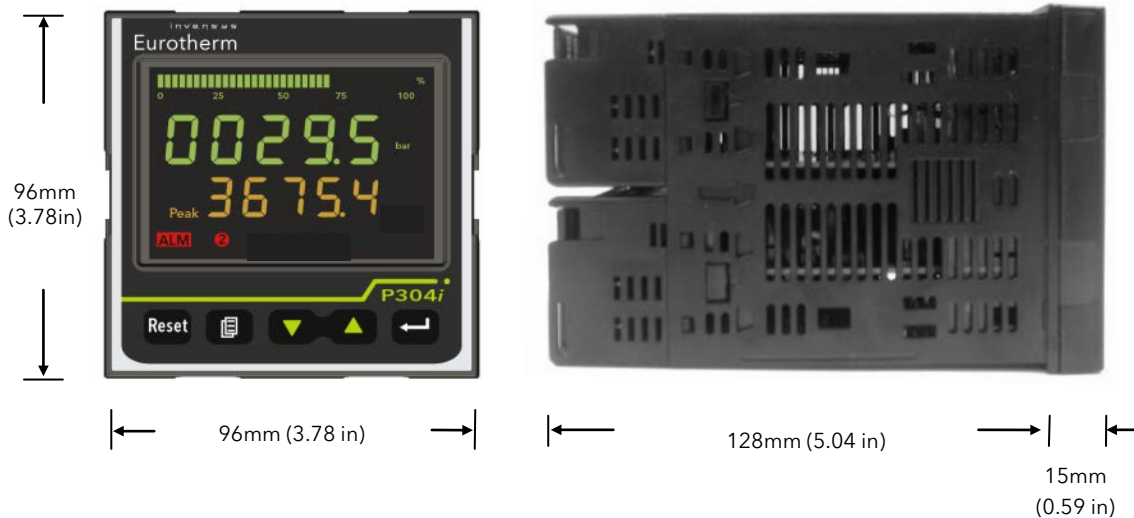

1.3 Step 1: Installation

This instrument is intended for permanent installation, for indoor use only, and enclosed in an electrical panel. Select a location which is subject to minimum vibrations the ambient temperature is within 0 and 50°C (32 - 122°F) and operating humidity of 0 to 85% RH non condensing.

The instrument can be mounted on a panel up to 25mm thick.

To ensure panel sealing, mount on a non-textured surface.

Please read the safety information in section 2 before proceeding. An EMC Booklet, part number HA025464, gives further installation information and can be downloaded from www.eurotherm.co.uk.

1.3.1 Panel Mounting the Indicator

The instrument can be fitted into a panel up to 25mm thick.

1. Prepare a cut-out in the mounting panel to the size shown. If a number of instruments are to be mounted in the same panel observe the minimum spacing shown.
2. Carefully remove the panel retaining clips (3) from the sleeve.
3. To achieve panel sealing, make sure the gasket (1) is fitted behind the front bezel of the indicator
4. Insert the indicator (2) through the cut-out
5. Fit one panel securing clip to the top of the indicator sleeve and the second clip diagonally opposite on the underneath of the sleeve in the slots provided
6. Tighten the panel securing clips using a screwdriver to a torque of between 0.3 and 0.4 Nm
7. To remove the controller from its sleeve, ease the latching ears (4) outwards and pull the controller forward out of the sleeve. When refitting ensure that the latching ears click back into place to maintain the panel sealing

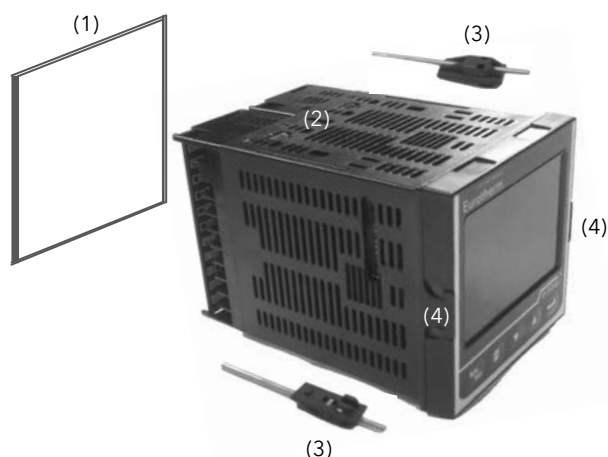

1.3.2 Panel Cut Out Size

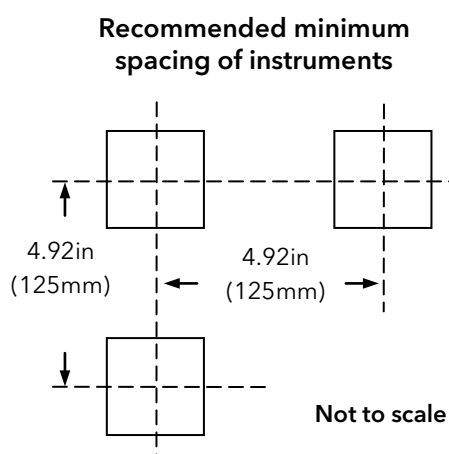
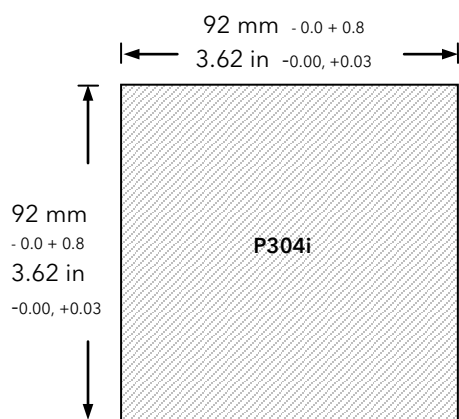

1.4 Order Code

	1.	2.	3.	4.	5.	6.
Model	Function	Power Supply	Second Input	Options	Custom Label	Special

	Model Number
P304i	¼ DIN indicator

1.	Function
AL	Process indicator

2.	Power Supply
VH	100 - 230Vac 50/60Hz
VL	24Vac / Vdc

3.	Second Input
XXX	None
PV2	Linear, TC, RTD, strain gauge

4.	Options
XXXX	None
SDXX	24Vdc TPSU + 2 nd analogue DC retransmission
SD4X	24Vdc TPSU + 2 nd analogue DC retransmission + RS 485

5.	Custom Label
XXXXXX	None

6.	Special
XXXXXX	None

1.5 Step 2: Wiring

1.5.1 Rear Terminal Connections

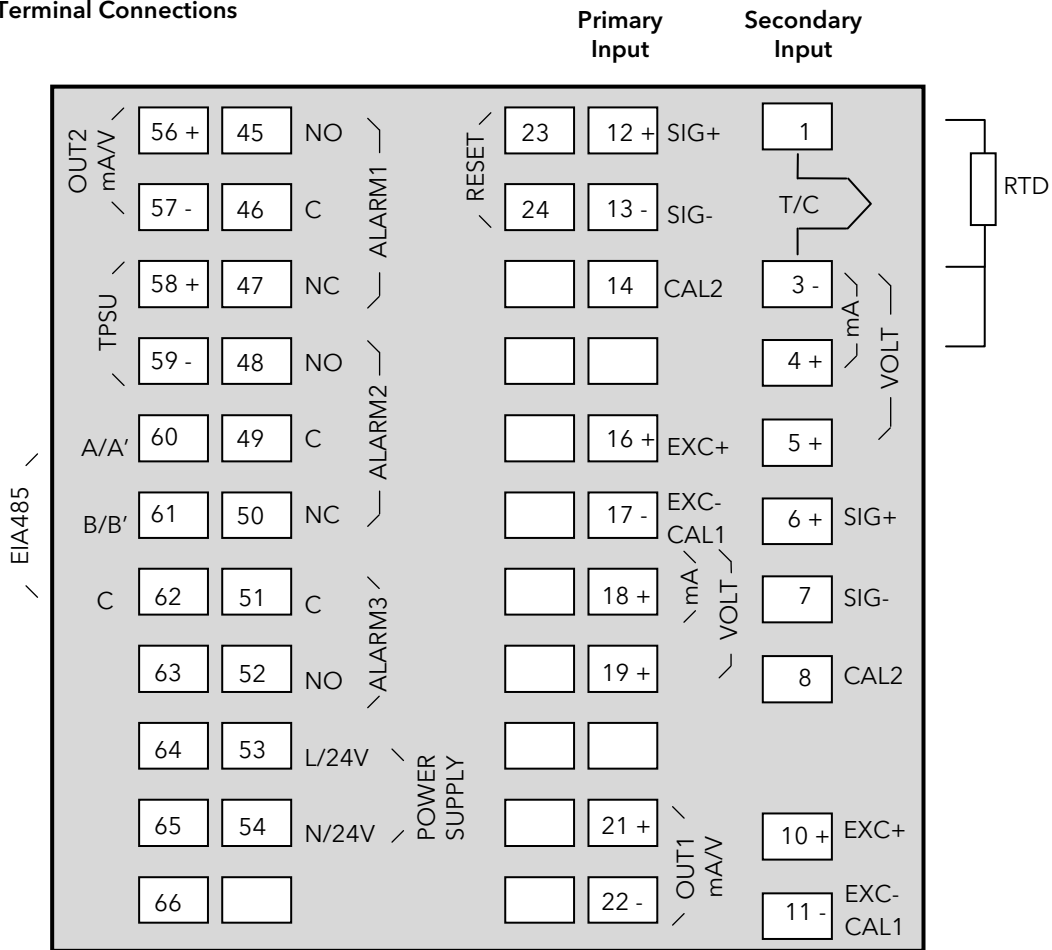

1.5.2 Block Diagram and Isolation Boundaries

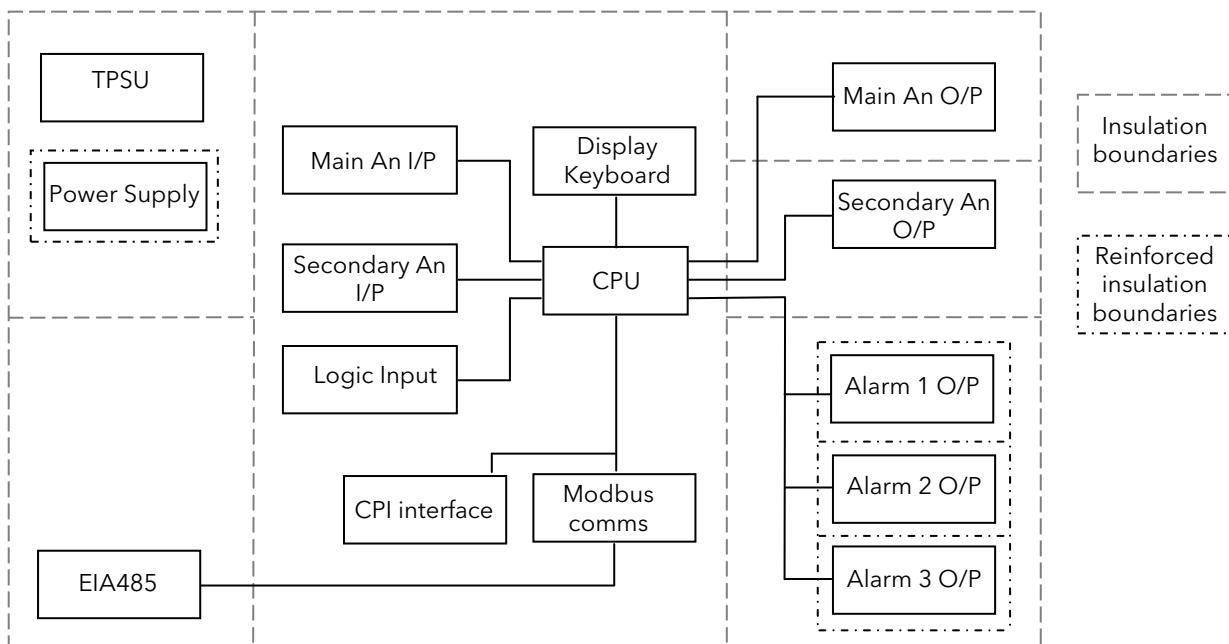

1.5.3 Wire Sizes

The screw terminals accept wire sizes from 0.5 to 1.5 mm (16 to 22AWG). Hinged covers prevent hands or metal making accidental contact with live wires. The rear terminal screws should be tightened to torque of between 0.3 and 0.4 Nm

The specification given in the following sections are a summary only. For full specifications see section 10.

1.5.4 Power Supply

1. Before connecting the instrument to the power line, make sure that the line voltage corresponds to the description on the identification label.
2. Use copper conductors only.
3. For 24V the polarity is not important
4. The power supply input is not fuse protected. This should be provided externally

Recommended external fuse ratings are as follows:-

For 24 V ac/dc, fuse type: T rated 2A 250V

For 100-230Vac, fuse type: T rated 2A 250V.

- A switch or circuit breaker must be included in the building installation
- It shall be in close proximity to the equipment and within easy reach of the operator
- It shall be marked as the disconnecting device for the equipment.

Notes: A single switch or circuit breaker can drive more than one instrument.

An earth (ground) connection is not required.

1.5.4.1 High Voltage Power Supply - Order Code VH

53	→	Line	<ul style="list-style-type: none"> • 100 to 230Vac, $\pm 15\%$, 50 to 60 Hz • Power rating: 22VA at 50Hz; 27VA at 60Hz.
54	→	Neutral	

1.5.4.2 Low Voltage Power Supply - Order Code VL

53	→	24V	<ul style="list-style-type: none"> • 24Vac, (14 to 32Vac) 50-60Hz • 24Vdc, (14 to 32Vdc) 5% max. ripple voltage • Power rating: 18VA at 24Vac 50/60Hz; 12W at 24Vdc • Polarity is not important.
54	→	24V	

1.5.5 Sensor Inputs

Precautions

- Do not run input wires together with power cables
- When shielded cable is used, it should be grounded at one point only
- These inputs are isolated

1.5.5.1 Pressure Transducer - Primary Input/Secondary Input

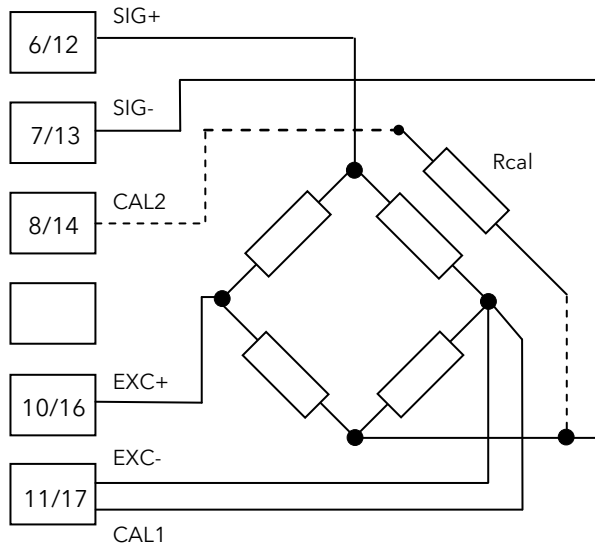

The diagram shows a pressure transducer with internal calibration resistor.

For transducers without an internal resistor connect an external resistor between terminals 13 and 14 (primary input) or 7 and 8 (secondary input).

The resistor is only switched in when calibrating the transducer. See section 3.10.

For transducer terminal numbers, refer to the manufacturers data.

1.5.5.2 2 Wire Transmitter

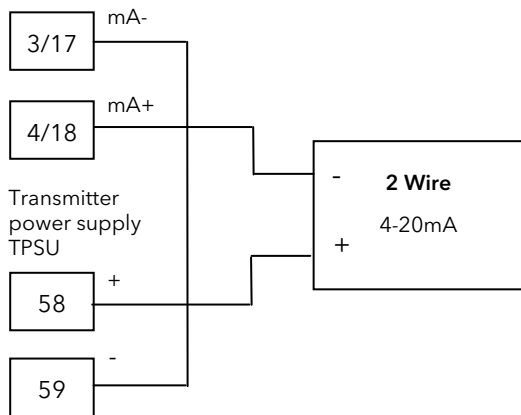

These inputs may be used to measure differential pressure. A typical example measures the pre and post screen pressures in screen changer applications.

1.5.5.3 4 Wire Transmitter

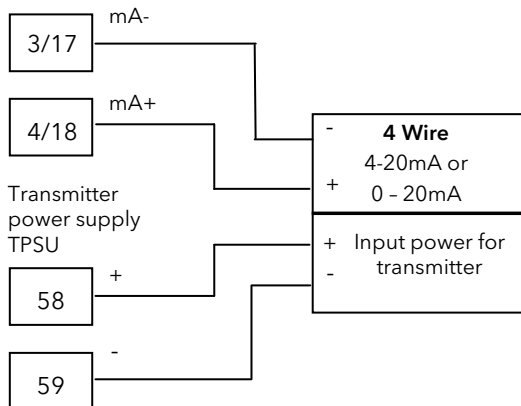

1.5.5.4 mA - Primary Input/Secondary Input

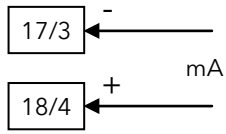

- Ranges: 0-20mA, 4-20mA configurable
- It is not necessary to fit a burden resistor to the mA inputs since this is connected internally.

1.5.5.5 Voltage - Primary Input/Secondary Input

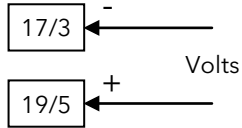

- Ranges: 0-5V, 0-10V configurable

1.5.5.6 Thermocouple Input

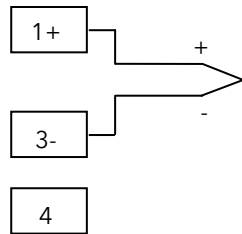

- Use appropriate compensating cable to extend cabling
- Pay attention to intermediate connections, i.e. make sure that the positive cable is connected to positive throughout and negative is connected to negative throughout.
- Avoid thermal junctions

1.5.5.7 Platinum Resistance Thermometer Input

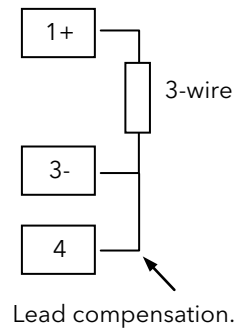

- 3-wire, line compensation up to 20Ω per wire for Pt100 and Pt500 sensors
- If a 2 wire RTD is used, link terminals 3 and 4

1.5.6 Transmitter Power Supply (TPSU)

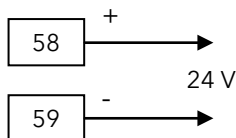

- 24Vdc +/- 2%, 1.5W optional supply for two or four wire transmitters

1.5.7 Analogue Outputs

Two analogue outputs are provided. OUT1 and OUT2. Each can be configured, using the appropriate 'P' codes (section 5.3), to retransmit the pressure as measured on the primary input or temperature as measured on the secondary input.

1.5.7.1 Retransmission Output (OUT1)

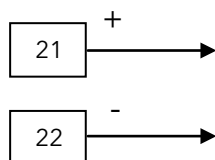

- Opto-isolated from CPU, input and output circuits
- 0/10 VDC min. load 5 k Ω , with under/over-range capability from -2.5 to 12.5 V (default).
- -10/+10 VDC min. load 5 k Ω , with under/over-range capability from -12.5 to 12.5 V.
- 0/5 VDC min. load 5 k Ω , with under/over-range capability from -1.25 to 6.25 V.
- 0/20 mA max. load 500 Ω , with under/over-range capability from -5 to 25 mA (max. load 400 Ω over 20 mA).
- 4/20 mA max. load 500 Ω , with under/over-range capability from 0 to 24 mA (max. load 400 Ω over 20 mA).
- Resolution: 0.1% of output span
- Scaling: The retransmission low and high limits are selectable from 0 to full scale input value. The input value may be pressure or secondary temperature depending on configuration. The two scaling values may be freely selectable within the above range, this allow to have a direct or reverse output type.
- Output filter: Selectable: OFF, 0.4, 1, 2, 3, 4, 5 seconds.

1.5.7.2 Retransmission Output (OUT2)

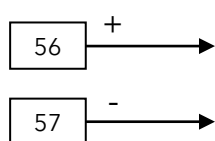

- Opto-isolated from CPU, input and output circuits
- 0/10 VDC min. load 5 k Ω , with under/over-range capability from -2.5 to 12.5 V (default).
- -10/+10 VDC min. load 5 k Ω , with under/over-range capability from -12.5 to 12.5 V.
- 0/5 VDC min. load 5 k Ω , with under/over-range capability from -1.25 to 6.25 V.
- 0/20 mA max. load 500 Ω , with under/over-range capability from -5 to 25 mA (max. load 400 Ω over 20 mA).
- 4/20 mA max. load 500 Ω , with under/over-range capability from 0 to 24 mA (max. load 400 Ω over 20 mA).
- Resolution: 0.1% of output span.
- Scaling: The retransmission low and high limits are selectable from 0 to full scale input value. The input value may be pressure or secondary temperature depending on configuration. The two scaling values may be freely selectable within the above range, this allow to have a direct or reverse output type.
- Output filter: Selectable: OFF, 0.4, 1, 2, 3, 4, 5 seconds

1.5.8 'Reset' Digital Input

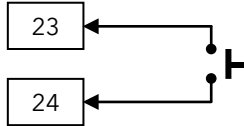

- Contact closure (voltage free)
- It may be keyboard programmable for the following functions using 'P' code P81:
 - alarm reset.
 - peak reset.
 - alarm and peak reset.
 - zero calibration of the primary input.
 - zero calibration of the primary input, alarm and peak reset.
- The access to the parameters by frontal keyboard is inhibited while the zero calibration is running.
- The reset functions (peak and alarm) are level-triggered; it means reset is active as long as the contact is closed.
- The zero calibration function is edge-triggered; it means calibration is started at contact closure.
- Not isolated with respect to analogue inputs.

1.5.9 Alarms

There are three standard alarms.

Each alarm is:

- Keyboard programmable using the appropriate 'P' codes for:
 - High / Low / Low masked on start up
 - Auto / Manual reset
 - Hysteresis - adjustable from 0.1% to 10% of span or one LSD (whichever is the greater)
 - Filter: Selectable from OFF, 0.4, 1, 2, 3, 4, 5 seconds.
 - By default relays are de-energised when the alarm is active (failsafe).
They can be re-configured to be energised in the alarm state see section 3.9.7 'Failsafe mode'.
- Varistor protected for spikes protection

1.5.9.1 Alarm 1

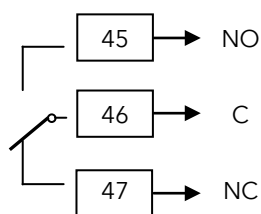

- 1 SPDT 2A maximum @240Vac resistive load

1.5.9.2 Alarm 2

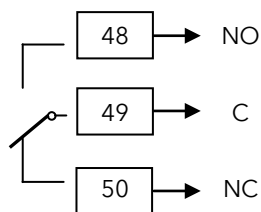

- 1 SPDT 2A maximum @240Vac resistive load

1.5.9.3 Alarm 3

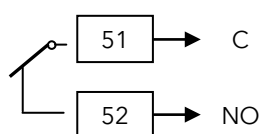

- 1 SPDT solder jumper selectable NO/NC (default NC) 2A maximum @240Vac resistive load

1.5.10 Modbus Serial Communications

Digital communications uses the Modbus protocol EIA485 2-wire.

☺ Cable screen should be grounded at one point only to prevent earth loops.

EIA485 Connections

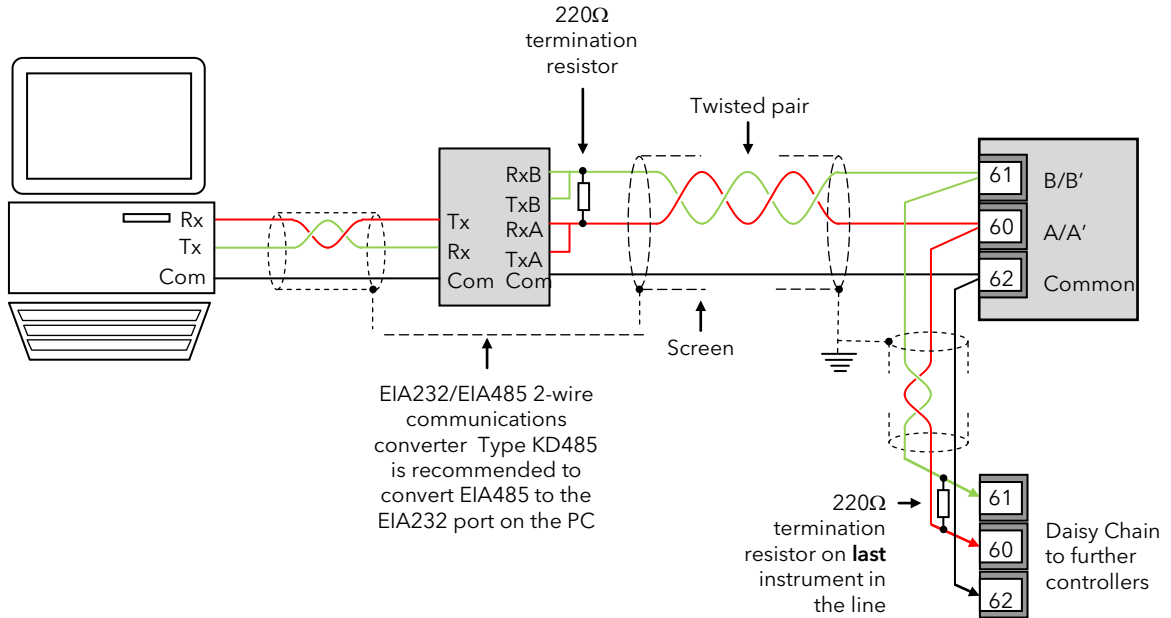

Note:

The device physical interface can only support up to 31 devices for each segment. More than 31 devices will require additional buffering. For more details see the Communications Manual HA026230 which can be downloaded from www.eurotherm.co.uk.

2. Safety and EMC Information

This instrument is intended for industrial temperature and process control applications within the requirements of the European Directives on Safety and EMC.

Information contained here is subject to change without notice. While every effort has been made to ensure the accuracy of the information, your supplier shall not be held liable for errors contained herein.

Safety and EMC protection can be seriously impaired if the unit is not used in the manner specified. The installer must ensure the safety and EMC of the installation.

This instrument complies with the European Low Voltage Directive 2006/95/EC, by application of safety standard EN 61010.

Unpacking and storage. If on receipt, the packaging or unit is damaged, do not install but contact your supplier. If being stored before use, protect from humidity and dust in an ambient temperature range of -20°C to $+70^{\circ}\text{C}$.

Electrostatic discharge precautions. Always observe all electrostatic precautions before handling the unit.

Service and repair. This instrument has no user serviceable parts. Contact your supplier for repair.

Cleaning. Isopropyl alcohol may be used to clean labels. Do not use water or water based products. A mild soap solution may be used to clean other exterior surfaces.

Electromagnetic compatibility. This instrument conforms to the essential protection requirements of the EMC Directive 2004/108/EC, by the application of a Technical Construction File. It satisfies the general requirements of the industrial environment defined in EN 61326-1.

Caution: Charged capacitors. Before removing an instrument from its sleeve, disconnect the supply and wait at least two minutes to allow capacitors to discharge. Avoid touching the exposed electronics of an instrument when withdrawing it from the sleeve.

Symbols. If symbols are used on the instrument, they have the following meaning:



Refer to manual.



Risk of electric shock.



Take precautions against static.



Protected by DOUBLE INSULATION

Installation Category and Pollution Degree. This unit has been designed to conform to EN61010 standard installation category and pollution degree, defined as follows:-

- **Installation Category II (CAT II).** The rated impulse voltage for equipment on nominal 230V supply is 2500V.
- **Measurement Category I (CAT 1).** All measurement circuits withstand a 1500V rated impulse voltage.
- **Pollution Degree 2.** Normally only non-conductive pollution occurs. However, a temporary conductivity caused by condensation must be expected.

Personnel. Installation must only be carried out by suitably qualified personnel

Enclosure of Live Parts. To prevent hands or metal tools touching parts that may be electrically live, the unit must be installed in an enclosure

Wiring. It is important to connect the unit in accordance with the data in this sheet. Always use copper cables. Wiring must comply with all local wiring regulations, i.e. UK, the latest IEE wiring regulations, (BS7671), and USA, NEC Class 1 wiring methods.

Voltage rating. The maximum voltage applied to the relay and logic output terminals must not exceed 230Vac +15%. The controller must not be wired to a three phase supply with an unearthed star connection.

Electrically Conductive pollution e.g. carbon dust, MUST be excluded from the unit enclosure. Where necessary, fit an air filter to the air intake of the enclosure. Where condensation is likely, include a thermostatically controlled heater in the enclosure.

Installation Requirements for EMC. To comply with European EMC directive certain installation precautions are necessary:-

- **General guidance.** Refer to EMC Installation Guide, Part no. HA025464.
- **Relay outputs.** It may be necessary to fit a suitable filter to suppress conducted emissions.
- **Table top installation.** If using a standard power socket, compliance with commercial and light industrial emissions standard is usually required. To comply with conducted emissions standard, a suitable mains filter must be installed.

3. Switch On

A brief self test start up sequence lights all segments of the display followed briefly by the firmware version number and the instrument type (P304i). The display then opens in Operator level 1 and a typical view is shown below



3.1 Operator Display

The indicator then opens in Operator level and a typical view is shown below.

Bar Graph - measured variable.
 Alarm setpoint values are displayed.
 First segment blinks for pressure lower than zero.
 Last segment blinks for pressure greater than full scale value.

Measured Value →

Selected parameter →
 Lit when the lower display shows:
Peak - peak value
PV2 - Temperature input value



Units ←
 kg/cm², psi, bar, MPa

Status indication ←

3.1.1 Status Indication

The status beacons shown below are illuminated to show the current status of the system.



Any alarm active (red)

Alarm 1, 2 or 3 active

Device controlled by serial link

3.1.2 Keyboard

The keyboard consists of five push-buttons, labelled as follows:

Reset	Press for more than 1 second to reset the stored peak value and to reset the alarms. This function is disabled when the device is controlled by serial link.
PAGE	Press for more than 4 seconds to select the level of operation (see section 3.5) . During parameter modification it is used to scroll back to the previous parameter without storing the parameter changes.
SCROLL	During parameter modification it is used to scroll forward to the next parameter and to store the parameter changes.
	Decrement or modify a parameter value.
	Increment or modify a parameter value. It may be used also to switch the lower display between measured (temperature) input ' PV2 ' and peak value ' Peak ' (if enabled). At power-on the lower display shows the temperature input (if present), otherwise it shows the peak value. If the peak detector is disabled, the lower display is blank.
or	Jump to max or min parameters value when instrument is in function mode.
or	Used only at power-up when the instrument detects a parameter error; see the "ERROR CODES" section 7.2 for further information.
Note:	Actions which require two or more pushbuttons to be pressed must follow exactly the pushbutton sequence shown.

3.1.3 Example - To Display Selected Parameters

The lower display can show a choice of:

- **Peak**. The peak value that the measured variable (pressure) has achieved between start of the process and a reset. On switch on the peak value is displayed.
- **PV2**. This is the remote setpoint value, for example temperature (if configured).

Press to switch between SP2 and Peak.

3.2 Open Indication

If the error message "OPEN" is displayed it is due to one or more of the following conditions:



- A/D converter saturation
- input current lower than 0.8 mA (for 4-20 mA inputs)
- pressure input lower than -25% or higher than 125% of full scale value
- "+SIG" or "-SIG" unconnected wire for strain gauge input
- linear temperature input lower than -1% or higher than 101% of full scale value
- one or more unconnected wires for thermocouple or RTD input
- excess of line resistance for thermocouple or RTD input
- thermocouple or RTD input value outside the specified range
- remote set point input lower than -1% or higher than 101% of full scale value

3.3 Levels of Operation

There are three levels of operation.

- **Level 1** *LEU1* This is designed for day to day operation so access to these parameters is not protected by a passcode.
- **Level 2** *LEU2* Parameters available in level 1 are also available in level 2. Level 2 contains a full set of parameters for commissioning purposes and more detailed operation. Level 2 can be protected by a passcode.
- **Configuration** *CONF* Configuration level sets all features of the instrument and is carried out using a list of 'P' codes. Each P code is associated with a particular feature of the instrument such as Input Type, Ranging, Outputs, Alarms, Digital Communications, etc. Configuration level can be protected by a passcode.

When Configuration level has been entered, two further levels may be selected as follows:-

Press and hold the  button again for about 4 seconds until the *GoTo* message is shown. Then press the  or  button to select **the Instrument Calibration level:-**

- **Instrument calibration** *ICAL* The instrument is supplied with all fitted circuits fully calibrated. Furthermore field fitted circuits do not require calibration since these boards are shipped from the factory full calibrated. However, this level is available to allow input and output circuits to be field calibrated if necessary. See section 7 for details.

When the desired level is selected press  button to confirm and to enter the level.

3.4 Level 1 Operation

At switch on the instrument enters Level 1.

Press to scroll through a list of parameters available in this level.

Press or to adjust an analogue value or a digital enumeration, provided that the parameter is not read only or has been locked in other levels.

3.4.1 Level 1 Parameters

For day to day operation the following list of parameters are available (depending on configuration).

Mnemonic (shown in the lower display)	Name	Availability	Explanation
<i>ALMAS</i>	ALARMS MASK RESET	Only if one or more alarms are configured with mask at start up	Use or to switch the upper display from <i>OFF</i> to <i>RESET</i> , then press to restore the alarm mask. See section 3.9.4.
<i>AL1</i>	ALARM 1 THRESHOLD	Only if P61 ≠ OFF	Used to set the point at which the alarm operates. The range is settable between the low and high scale of the related input. The high limit may be expanded to 110% of span. Default AL1 5%, AL2 60%, AL3 80% of range.
<i>AL2</i>	ALARM 2 THRESHOLD	Only if P65 ≠ OFF	
<i>AL3</i>	ALARM 3 THRESHOLD	Only if P69 ≠ OFF	
<i>P1, AL</i>	PRIMARY PRESSURE INPUT VALUE	Only if P11 ≠ OFF and P12 = <i>di, FFP</i>	This is read only and indicates the pressure measured if the transducer is connected to the primary input terminals.
<i>S1, AL</i>	SECONDARY PRESSURE INPUT VALUE		This is read only and indicates the pressure measured if the transducer is connected to the secondary input terminals.

3.4.2 Example - To Set Alarm 1 Threshold

Press until *AL1* is displayed

The current alarm level is shown in the upper (green) display.

Press to raise the alarm value

Press to lower the alarm value

} Press to confirm the new value.
The marker bar in the bar graph will also move to the new position.
Note: press to scroll back to previous parameters.

Alarm 2 and Alarm 3 can be adjusted in a similar way.

3.5 To Select Other Levels of Operation

To change the operating mode, follow the steps below:



1. Press and hold until the lower display shows "*GoGo*" in the lower display (approximately 4 seconds)
2. Press or to select the desired operating level on the upper display:
LEu1 Normal operative mode Level 1
LEu2 Normal operative mode Level 2
ConF Configuration level
3. Confirm the choice by pressing .
4. Enter the passcode (if configured) using or . *LEu2* default = 2. *ConF* default = 4.
5. Press to accept the value. If passcodes are not configured the selected level will be entered at 3 above.

3.6 Level 2 Operation



Level 2 parameters also include Level 1 parameters.

To select a parameter:-

Press  to scroll through a list of parameters.

Press  or  to adjust an analogue value or a digital enumeration, provided that the parameter is not read only or has been locked in configuration level.

3.6.1 Level 2 Parameters

Mnemonic Shown in the lower display	Parameter	Availability	Notes	Further Information
ALMRS	ALARMS MASK RESET	Only if one or more alarms are configured with mask at start up	see 'Level 1 Parameters'	Section 3.9.4
AL1	ALARM 1 THRESHOLD	If P61 ≠ OFF	see 'Level 1 Parameters'	Section 3.4.1
ALH1	ALARM 1 HYSTERESIS	If P61 ≠ OFF	Range 0.1 to 10.0% of the instrument range. Default = 1.0.	
AL2	ALARM 2 THRESHOLD	If P65 ≠ OFF	see 'Level 1 Parameters'	
ALH2	ALARM 2 HYSTERESIS	If P65 ≠ OFF	Range 0.1 to 10.0% of the instrument range. Default = 1.0.	
AL3	ALARM 3 THRESHOLD	If P69 ≠ OFF	see 'Level 1 Parameters'	
ALH3	ALARM 3 HYSTERESIS	If P69 ≠ OFF	Range 0.1 to 10.0% of the instrument range. Default = 1.0.	
P1AL	PRIMARY PRESSURE INPUT VALUE	Only if P11 ≠ OFF and P12 = d, FFP	see 'Level 1 Parameters'	See also section 3.10
S1AL	SECONDARY PRESSURE INPUT VALUE			
LoC	ZERO CALIBRATION	Always	Use  or  to switch upper display from OFF to On . Then press  to start the calibration. It is also possible to select CLER to delete field calibration and restore factory calibration. Default: Zero calibration: 0 Span calibration: Full scale for linear input; 33.3mV for strain gauge.	
Lo2C	ZERO CALIBRATION FOR SECONDARY INPUT	If P11 ≠ OFF & P12 = d, FFP		
HiC	SPAN CALIBRATION	Always		
Hi2C	SPAN CALIBRATION FOR SECONDARY INPUT	If P11 ≠ OFF & P12 = d, FFP		
dSPFL	DISPLAY FILTER	Always	Time constant of the filter	Section 3.9.10
AL1FL	ALARM 1 FILTER	If P61 ≠ OFF	Range OFF, 0.4, 1, 2, 3, 4, 5 sec. Default = 0.4 second	
AL2FL	ALARM 2 FILTER	If P65 ≠ OFF		
AL3FL	ALARM 3 FILTER	If P69 ≠ OFF		
MoFL	MAIN ANALOGUE OUTPUT FILTER	If P31 ≠ OFF	Time constant of the retransmission output filter Range OFF, 0.4, 1, 2, 3, 4, 5 sec. Default = 0.4 second	
SoFL	SECONDARY ANALOGUE OUTPUT FILTER	If P51 ≠ OFF		
				'P' codes are found in section 5.3

3.7 To Return to Level 1

1. Press and hold  until the lower display shows "**LoLo**" in the lower display (approximately 4 seconds)
2. Press  or  to select **LEU1**

3.8 Alarms

Alarms are used to alert an operator when a pre-set level has been exceeded. The threshold value can be set in Level 1 (or 2) by the alarm setpoint parameters *AL 1*, *AL 2* or *AL 3*.

They are indicated by lighting the alarm number **1**, etc. and the red **ALM** beacon in the display.

Alarm 1 operates the change-over relay connected to terminals 45, 46 and 47.

Alarm 2 operates the change-over relay connected to terminals 48, 49 and 50.

Alarm 3 operates the normally closed relay connected to terminals 51 and 52.

The alarm relays may be energised or de-energised in alarm as set by the Fail Safe mode described below.

Each alarm can be configured using 'P' codes as follows:-

• Off / Primary pressure input/ Secondary (temperature) input	(P61 - Alarm 1; P65 - Alarm 2; P69 - Alarm 3)
• High / Low / Low inhibited on start up	(P62 - Alarm 1; P66 - Alarm 2; P70 - Alarm 3)
• Auto / Latching	(P63 - Alarm 1; P67 - Alarm 2; P71 - Alarm 3)

3.9 Definition of Alarm Types

Alarm types are configured using two parameters, e.g. P61 and P62 for Alarm 1 as shown in the table above. Alarm types are illustrated using examples in the sections below.

3.9.1 Process High

An alarm will activate if the measured value exceeds an absolute high value set by the alarm threshold.

The alarm will reset when the measured value falls below the value set by the hysteresis parameter.

Example:

Alarm 1 = Process high (set by P61 and P62).

Controller input range = 3000psi (set by P3).

Alarm threshold = 2000psi, set in Level 2 by AL1. (Note: the alarm threshold can be set between 0 and 3300).

Alarm hysteresis = 1.0% of controller input range i.e. 30psi.

The alarm will activate when the input level rises above 2000psi.

The alarm will de-activate when the input level drops below 1970psi.

This is shown graphically for a rising and falling input signal (and assumes the alarm is not a latching type).

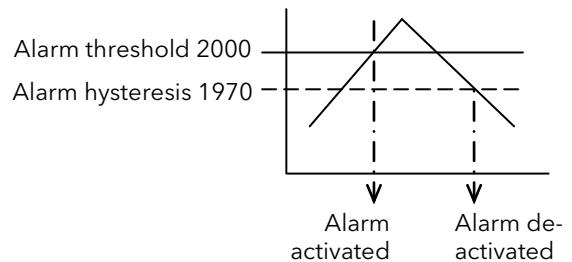

3.9.2 Process Low

An alarm will activate if the measured value exceeds an absolute low value set by the alarm threshold.

Example:

Alarm 1 = Process low (set by P61 and P62).

Controller input range = 3000psi (set by P3).

Alarm threshold = 700psi, set in Level 2 by AL1. (Note: the alarm threshold can be set between 0 and 3300).

Alarm hysteresis = 1.0% of controller input range i.e. 30psi.

The alarm will activate when the input level falls below 700psi.

The alarm will de-activate when the input level rises above 730psi.

This is shown graphically for a rising and falling input signal (and assumes the alarm is not a latching type).

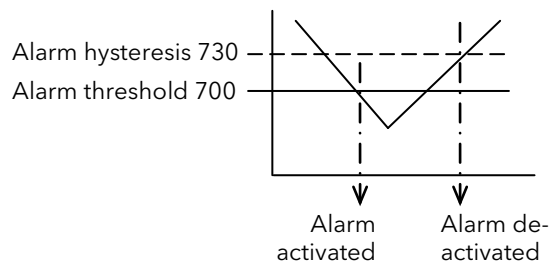

3.9.3 Alarm Mask at Start up

Alarm mask at start up is used to inhibit the activation of an alarm during start up of the process. When the process has reached steady state conditions and has achieved the safe state defined by the alarm threshold the mask is removed. Only then will an alarm be triggered if the process exceeds the threshold.

3.9.4 Alarm Mask Reset

The alarm mask may be restored using the keyboard parameter (*AL MRS*) available in Levels 1 & 2.

3.9.5 Alarm Reset Mode

This can be set using 'P' code P63, P67 or P71 as Auto or Latching.

An **auto alarm** does not require acknowledgement. The alarm is no longer active as soon as the alarm condition is removed.

A **latching alarm** continues to be active until both the alarm condition is removed AND the alarm is acknowledged. The acknowledgement can only occur AFTER the condition causing the alarm is removed.

3.9.6 Alarm Acknowledgement

An alarm may be acknowledged by closing an external contact on the **RESET** input on terminals 23 and 24 - normally an external pushbutton.

3.9.7 Failsafe mode

See 'P' codes P64 - Alarm 1; P68 - Alarm 2; P72 - Alarm - 3.

Failsafe - relay coil energized in no alarm condition. This means that if power is removed from the controller the relay will relax to indicate an alarm state, assuming, of course, that power remains on to the external alarm circuitry.

Non-failsafe - relay coil energized in alarm condition.

The default condition is failsafe.

3.9.8 Threshold

This is the value at which the alarm is to operate and may be set in Levels 1 & 2. Range is from 0 to 110% Full Scale (the threshold may be limited due to the selected full scale value).

3.9.9 Hysteresis

Hysteresis is the difference between the point at which the alarm switches 'ON' and the point at which it switches 'OFF'. It is used to provide a definite indication of the alarm condition and to prevent alarm relay chatter. It is particularly useful in conditions where the PV is noisy. Hysteresis set for each alarm in Level 2 from 0.1% to 10.0% of span or 1 Least Significant Digit (whichever is greater).

3.9.10 Alarm Filter

A time constant can be added to an alarm to prevent spurious switching in the event of a noisy input signal. It is available in Level 2 for each alarm and is selectable from: OFF, 0.4s, 1s, 2s, 3s, 4s, 5s.

3.9.11 Behaviour of Alarms after a Power Cycle

If an alarm is active when the power is switched off and is still active when the power is restored the alarm condition will be detected.

If an alarm is active when the power is switched off and is no longer active when the power is restored no alarm will be detected.

3.10 Pressure Transducer Calibration

This section describes how to calibrate the instrument to the particular pressure transducer being used. The instrument should be powered up for at least 15 minutes and allow the transducer to reach operating conditions.

3.10.1 Calibration of a Pressure Transducer fitted with an internal shunt resistor.

Assume the transducer, with no load, is connected to the Primary Input. If the instrument has not been configured then carry out the following steps in Configuration Level. If it has been configured then calibration is performed as described below in Level 2.

Configure the Indicator

In configuration level set the relevant 'P' codes for the transducer being calibrated, for example:

- P1 = **5tr**
- P2 = pressure units, e.g. psi
- P3 = full scale range of the strain gauge, e.g. 10000 psi
- P4 = the minimum scale range of the strain gauge, e.g. 0 psi
- P5 = the required decimal point position
- P6 = As selected - usually high
- P7 = On. Shunt calibration enabled, if the pressure transducer is fitted with an internal shunt resistor.
- P8 = the correct percentage (80% for a typical transducer).

In Level 2

1. Open the calibration switch (if fitted)
2. Select **LoL** (low calibration for the primary input). Ensure that no pressure is applied to the transducer.
3. Use **▼** or **▲** to switch upper display from **OFF** to **0n**.
4. Then press **↵** to start the low calibration.
5. The instrument calibrates to zero pressure
6. Close the calibration switch
7. Select **HiL** (span calibration for the primary input. Note this is normally 80% of span but can be changed by P8 to suit a specific transducer.)
8. Use **▼** or **▲** to switch upper display from **OFF** to **0n**.
9. Then press **↵** to start the calibration.
10. The instrument calibrates to 80% of its span

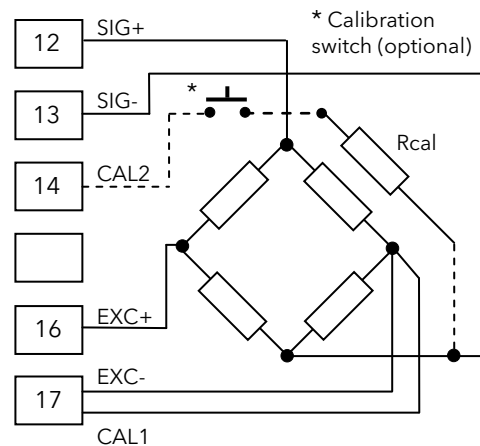

3.10.2 Calibration of a Pressure Transducer with an external shunt resistor

Connect the external shunt resistor (value as specified by the transducer manufacturer) across terminals 13/14. Ensure that the full scale and low scale values have been set to match the range of the transducer, the Shunt function is On and P8 is set to the correct percentage as listed above.

In Level 2, repeat steps 1 to 8 above.

Note: The transducer may also be connected to the secondary input using terminals 6 to 11.

3.10.3 Calibration of an amplified pressure transducers with an internal shunt resistor

In configuration level ensure that P7 is set to OFF, then repeat steps 1 to 8 above.

3.10.4 Calibration of pressure transducer connected to the secondary input

This is the same as above but in Level 2 use the **Lo2L** (zero calibration) and **Hi 2L** (Span calibration) parameters instead of **LoL** and **HiL**.

4. Indicator Block Diagram

The block diagram shows the function blocks which make up the instrument. Where applicable, each block is represented by the 'P' code as described in the section 5.3.

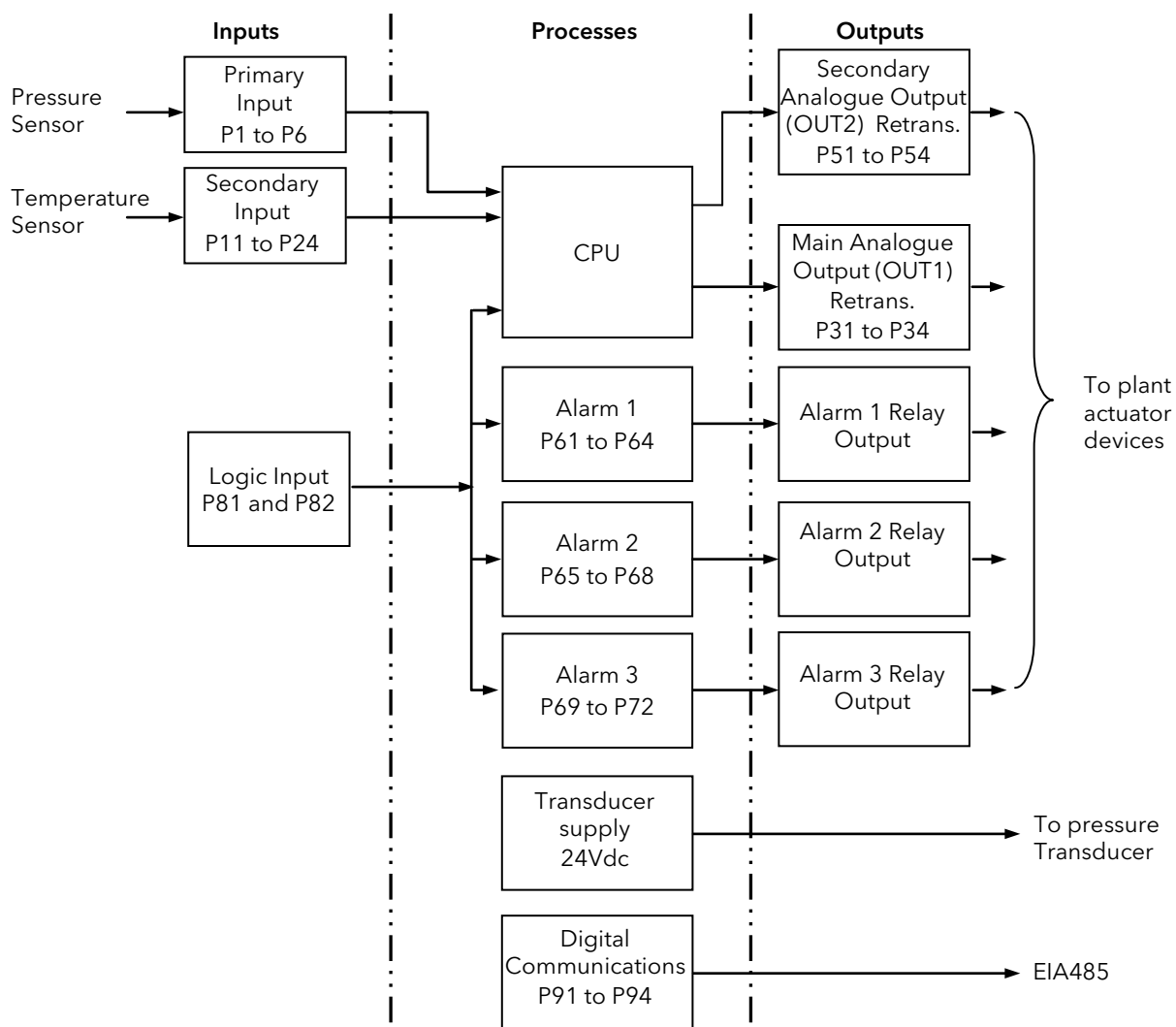

The pressure is measured by the pressure transducer which can be connected to either the Primary or Secondary Inputs (although if temperature is to be measured the pressure should be connected to the primary input). The analogue value can be retransmitted using both output 1 (OUT1) and output 2 (OUT2).

It is also possible to measure the temperature using the Secondary Input.

The three alarm blocks monitor the measured pressure or the measured temperature and can be configured to respond to high or low alarms and operate relay outputs.

EIA485 digital communications provides an interface for data collection, monitoring and remote control.

The way in which each block performs is defined by its internal parameters. Some of these parameters are available to the user so that they can be adjusted to suit the characteristics of the process.

These parameters are found in lists in Operator Level 1, Operator Level 2 and Configuration level ('P' codes shown in the following section).

5. Configuration Level

Configuration of the instrument is carried out using a list of 'P' codes. Each P code is associated with a particular feature of the indicator such as Input Type, Ranging, Outputs, Alarms, Digital Communications, Calibration, etc. These are listed in the tables in section 5.3.



WARNING

Configuration level gives access to a wide range of parameters which match the instrument to the process. Incorrect configuration could result in damage to the process and/or personal injury. It is the responsibility of the person commissioning the process to ensure that the configuration is correct.

In configuration level the indicator does not provide alarm indication.





Do not select configuration level on a live process.

5.1 To Select Configuration Level

1. Press and hold  until the lower display shows "GoTo" in the lower display (approximately 4 seconds)
2. Press  or  to select **Conf**

5.2 Configuration Level Parameters

Configuration parameters are defined by a set of 'P' codes.

1. Press  to scroll through the list of 'P' codes.
2. Press  or  to select the function associated with the 'P' code.
3. Press  to accept the function.



To scroll back press .

A summary and description of the 'P' codes is given in the following sections.

5.3 Configuration - 'P' Codes

Use these codes to configure the indicator to meet the requirements of the process.

5.3.1 Summary

This section gives an overview of the 'P' codes.

Sensor input and Ranging	<i>P1</i>	Pressure input selection	Secondary Analogue Output	<i>P51</i>	Secondary analogue output selection	
	<i>P2</i>	Pressure input engineering unit		<i>P52</i>	Secondary analogue output link	
	<i>P3</i>	Pressure input full scale value		<i>P53</i>	Secondary analogue output range low	
	<i>P4</i>	Pressure input low scale value		<i>P54</i>	Secondary analogue output range high	
	<i>P5</i>	Pressure input decimal point position		Alarms	<i>P61</i>	Alarm 1 input channel link
	<i>P6</i>	Pressure input fail safe			<i>P62</i>	Alarm 1 type
Calibration	<i>P7</i>	Shunt calibration	<i>P63</i>		Alarm 1 reset mode	
	<i>P8</i>	Shunt value	<i>P64</i>		Alarm 1 failsafe mode	
Secondary Input	<i>P9</i>	Display update time for the pressure input	<i>P65</i>		Alarm 2 input channel link	
	<i>P11</i>	Secondary input selection	<i>P66</i>		Alarm 2 type	
	<i>P12</i>	Secondary input function	<i>P67</i>		Alarm 2 reset mode	
	<i>P13</i>	Thermocouple type	<i>P68</i>		Alarm 2 failsafe mode	
	<i>P14</i>	RTD type	<i>P69</i>		Alarm 3 input channel link	
	<i>P15</i>	Temperature units	<i>P70</i>		Alarm 3 type	
	<i>P16</i>	Temperature range low	<i>P71</i>		Alarm 3 reset mode	
	<i>P17</i>	Temperature range high	<i>P72</i>		Alarm 3 failsafe mode	
	<i>P18</i>	Temperature decimal point position	Logic input	<i>P81</i>	Logic input configuration	
	<i>P19</i>	Secondary input full scale value		<i>P82</i>	Logic input status	
	<i>P20</i>	Secondary input low scale value	Peak detection	<i>P83</i>	Peak detection	
	<i>P21</i>	Secondary input fail safe	Line frequency	<i>P84</i>	Line frequency	
<i>P24</i>	Secondary input sample time	<i>P85</i>		Line frequency readout		
Main Analogue Output	<i>P31</i>	Main analogue output selection	Auto/Manual	<i>P86</i>	Manual/auto start-up	
	<i>P32</i>	Main analogue output link		<i>P87</i>	Manual/auto transfer	
	<i>P33</i>	Main analogue output range low	Digital communications	<i>P91</i>	Serial communication interface address	
	<i>P34</i>	Main analogue output range high		<i>P92</i>	Protocol type	
Configuration recovery	<i>rEcL</i>	Recovery point		<i>P93</i>	Communication type	
				<i>P94</i>	Communication baud rate	
Pass codes	<i>P98</i>	Level 2	<i>P99</i>	Configuration level		

5.3.2 Pressure Input Selection

Code	Description	Range	
P1	Configures the Type of Pressure Input . Note: Remember to properly wire the unit's terminal block	Str	Strain gauge (default)
		0-20	0-20 mA
		4-20	4-20 mA
		0-5	0-5V
		0-10	0-10V
P2	Configures the Pressure Input Engineering Unit Changing the Engineering Unit causes the scaling of parameter values linked to the pressure input. (for example: if P2 = 10000 PSI , changing from PSI to BAR automatically scales P2 to 689 BAR)	OFF	Off all beacons are turned off
		h0cn2	kg/cm ² beacon lit
		PSI	psi beacon lit
		bARr	bar beacon lit (default)
		nPA	MPa beacon lit
P3	Configures the Full Scale Value for the Pressure Input Changing to this value causes the loading of the default values for the pressure input low scale, the alarm set points, the remote set point limits, the set point limits, the set point and the retransmission limits and the secondary input low/high range is reset to the primary input value.	from 10 to 99950	Default 10000
P4	Configures the Low Scale Value for the Pressure Input	from +/- 25% of Full scale value.	Default 0
P5	Configures the Pressure Input Decimal Point Position Use ▲ or ▼ keys to select the position of the decimal point.	nnnnn nnnn.n nnn.nn nn.nnn n.nnnn	Default nnnnn
P6	Configures the Pressure Input Fail Safe Condition	Hi	High (default)
		Lo	Low

5.3.3 Shunt Calibration

Code	Description	Range	
P7	Configures the Shunt Calibration . This parameter is set to On to enable field calibration of the pressure transducer. See also section 3.10.	OFF	Off
		On	On (default)
P8	Configures the Shunt Value This is the value at which the pressure transducer is calibrated and is normally stated by the manufacturer of the unit.	From 40.0 to 100.0%	Default 80.0%

5.3.4 Pressure Input Display Update Time

Code	Description	Range	
P9	Configures the Display update time for the pressure transducer . A fast update time can be useful to get the display refreshed at every analogue to digital converter sample. However, there are instances when this can be a distraction. For this reason display update time may be selected to suit individual preferences.	0.050	50 mS
		0.100	100mS
		0.250	250mS
		0.400	400mS

5.3.5 Secondary Input

Code	Description	Range		
P 11	Configures the Secondary Input Type Remember to properly wire the unit's terminal block.	OFF	Disabled	
		tc	Thermocouple	
		rtd	Platinum resistance thermometer	
		0-20	0-20mA	
		4-20	4-20mA (default)	
		0-5	0-5 Volts	
		0-10	0-10 Volts	
		Str	Strain Gauge	
P 12	Configures the Function of the Secondary Input It is available only if P11 is different from OFF. It is alterable if P11 = mA or V inputs; otherwise it is forced to the P11 value.	TEMP	The input acts as a temperature input	
		differential	The input acts as the second sensor for differential pressure measurement	
P 13	Configures the thermocouple type of the temperature input	If P11 = TC	Thermocouple type.	
			tc J	Type J (default)
			tc K	Type K
			tc L	Type L
			tc N	Type N
			tc T	Type T
P 14	Configures the RTD type of the temperature input	If P11 = RTD	PRT type. Pt 100 (default), Pt500	
P 15	Configures the units of the temperature input	If P11 = TC or RTD	Temperature units. FAHr Fahrenheit (default), CEL Celsius Values linked to the temperature input are scaled automatically.	
P 16	Configures the secondary input range low	If P11 = V or mA & P12 = TEMP	-1000 to 3000. Default - 0	
P 17	Configures the secondary input range high		-1000 to 3000. Default - 1000	
P 18	Configures the secondary input decimal point position		Use ▲ or ▼ keys to select the position of the decimal point. Default - none	
P 19	Configures the Secondary input full scale value This must be set to match the range of the pressure transducer in use. It is available only if P11 is different from OFF and P12 is equal to differential.	From 0 to the full scale value	Default 10000 (psi)	
P 20	Configures the Secondary input low scale value. It is available only if P11 is different from OFF and P12 is equal to differential.	From +/- 25% of the 'Secondary input full scale value' set by P19	Default 0	
P 21	Configures the Secondary input fail safe condition It is available only if P11 is different from OFF and P12 is equal to differential.	HI	High (default)	
		LO	Low	

5.3.6 Main Analogue Output

This is a retransmission output on OUT1 on terminals 21 and 22.

Code	Description	Range	
P31	Configures the Type of output .	0-20	0-20mA
		4-20	4-20mA
		0-10	0-10 Volts (default)
		-10.10	-10 to +10 Volts
		0-5	0-5 Volts
P32	Configures the Main analogue output link	If P11 ≠ OFF & P12 = TEMP	<i>PrIn</i> (primary pressure input) <i>SecIn</i> (secondary temperature input). Default; <i>PrIn</i> .
P33	Configures the Main analogue output range low	Always	From 0 to P3 (if P32 = <i>PrIn</i>) -1000 to 3000 (if P32 = <i>SecIn</i>) Default; 0
P34	Configures the Main analogue output range high	Always	From 0 to P3 (if P32 = <i>PrIn</i>) -1000 to 3000 (if P32 = <i>SecIn</i>) Default; P3

5.3.7 Secondary Analogue Output

This is a retransmission output on OUT2 on terminals 56 and 57 if the output is fitted.

Code	Description	Range	
P51	Configures the Type of output .	OFF	Output disabled
		0-20	0-20mA
		4-20	4-20mA
		0-10	0-10 Volts (default)
		-10.10	-10 to +10 Volts
		0-5	0-5 Volts
P52	Configures the Secondary analogue output link	If P51 ≠ OFF & P12 = TEMP	<i>PrIn</i> (primary pressure input), <i>SecIn</i> (secondary temperature input). Default; <i>PrIn</i> .
P53	Configures the Secondary analogue output range low	If P51 ≠ OFF	From 0 to P3 (if P52 = <i>PrIn</i>) -1000 to 3000 (if P52 = <i>SecIn</i>) Default; 0
P54	Configures the Secondary analogue output range high	If P51 ≠ OFF	From 0 to P3 (if P52 = <i>PrIn</i>) -1000 to 3000 (if P52 = <i>SecIn</i>) Default; P3

5.3.8 Alarms

Up to three alarms can be configured. They are used to detect out of range values.

Code	Description	Range	
P61	Configures the Alarm 1 selection . All alarms can be attached to the measured pressure on the primary input, or the temperature on the secondary input.	OFF	Disabled
		PrIn	Primary - pressure input- default
		SecIn	Secondary - temperature input
P62	Configures the Alarm 1 type . Available only if P61 is different from OFF.	Hi	High (default) - an alarm will be triggered if the measured value exceeds a high setting
		Lo	Low - an alarm will be triggered if the measured value exceeds a low setting
		Inhib	Low with mask at start up (sometimes referred to as 'blocking'). A low alarm will be inhibited until the process has gone above the alarm value for the first time.
P63	Configures the Alarm 1 reset mode . Available only if P61 is different from OFF. The alarm reset mode determines if the alarm resets once the alarm condition is no longer true or whether the alarm needs to be reset manually.	Auto	Automatic (default). The alarm is no longer indicated once it is no longer true.
		LATCH	Latching. The alarm remains indicated even if it is no longer true. It can be manually reset by pressing the 'Reset' button on the front panel or by making a contact between terminals 23 and 24 (if P81 is configured as AL or AL-P).
P64	Configures the Alarm 1 failsafe mode . Available only if P61 is different from OFF. This parameter determines the action the alarm will take in the event of a power fail to the instrument. In failsafe mode when the controller is powered on the normally closed contact is held open while the normally open contacts are held closed . On power failure they are released as the relay relaxes. This feature should be used as a shut down alarm.	FS	Failsafe (default). In the event of a power fail the alarm will activate.
		nFS	Non failsafe
P65	Configures the Alarm 2 selection .	Same as P61	
P66	Configures the Alarm 2 type Available only if P65 is different from OFF.	Same as P62	
P67	Configures the Alarm 2 reset mode . Available only if P65 is different from OFF.	Same as P63	
P68	Configures the Alarm 2 failsafe mode Available only if P65 is different from OFF.	Same as P64	
P69	Configures the Alarm 3 selection .	Same as P61	
P70	Configures the Alarm 3 type Available only if P69 is different from OFF.	Same as P62	
P71	Configures the Alarm 3 reset mode . Available only if P69 is different from OFF.	Same as P63	
P72	Configures the Alarm 3 failsafe mode Available only if P69 is different from OFF.	Same as P64	

5.3.9 Logic Input

The Logic Input is fitted as standard and can be configured as a reset for alarms or peak detection, or it can be used to externally select the pressure transducer calibration. It is a contact closure input but is edge triggered on contact closure.

Code	Description	Range	
P81	Configures the Logic Input This is the logic input connected to terminals 23 and 24. Do not confuse this with the digital inputs DIG1 to DIG4 which have fixed functionality.	OFF	Disabled
		AL	Alarm reset
		P	Peak reset
		AL-P	Alarm + peak reset (default)
		CAL0	Zero calibration
		ALL	Zero calibration + alarm reset + peak reset
P82	Configures the Status of the logic input Available only if P81 is different from OFF	CLOSE	The logic input is considered active when the contact is closed (default)
		OPEN	The logic input is considered active when the contact is open

5.3.10 Peak Detection

Code	Description	Range	
P83	Configures the Polarity of the peak detection P83 determines whether the maximum or minimum value of the measured signal is recorded by the indicator. The value is stored until it is reset by the front panel Reset key or by an external connection across terminals 23 and 24, (assuming P81 is configured as AL or AL-P).	OFF	Disabled
		HI	Maximum peak (default)
		LO	Minimum peak

5.3.11 Line Frequency

Code	Description	Range		
P84	Configures the Line frequency rejection The frequency of the ac supply can be detected automatically or selected manually. It does not apply to certain conditions such as 24V DC power supply.	50	50 Hz	
		60	60 Hz	
		Auto	Line frequency is detected automatically (default).	
P85	Configures the Line frequency readout . This is a read only value of the detected line frequency. Available only when P84 is set to Auto.	50	50 Hz.	when the device is able to detect correctly 50 or 60 Hz line frequency
		60	60 Hz	
		Und50	automatic detection of the line frequency does not work (e.g. 24V DC power supply); a 60 Hz rejection is assumed.	

5.3.12 Digital Communications

Digital communications is orderable. It uses Modbus or Jbus protocol and EIA485 2-wire interface.

Code	Description	Range	
<i>P91</i>	<p>Configures the Serial communication interface address.</p> <p>Available only if Modbus/Jbus serial communication interface is fitted.</p> <p>On a network of instruments the address is used to specify a particular instrument. Each instrument on a network should be set to a unique address from 1 to 255.</p>	<i>OFF</i>	Disabled (default)
		<i>1 to 255</i>	An address of 1 to 255 can be set for any particular instrument.
<i>P92</i>	<p>Configures the Protocol type.</p> <p>Available only P91 is different from OFF.</p>	<i>ModbS</i>	Modbus (default)
		<i>JbUS</i>	Jbus
<i>P93</i>	<p>Configures the Parity type.</p> <p>Available only P91 is different from OFF.</p> <p>Parity is a method of ensuring that the data transferred between devices has not been corrupted. Parity is the lowest form of integrity in the message, it ensures that a single byte contains either an even or an odd number of ones or zeros in the data. In industrial protocols, there are usually layers of checking to ensure that first the byte transmitted is good and then that the message transmitted is good. Modbus applies a CRC (Cyclic Redundancy Check) to the data to ensure that the packet of data is not corrupted. Thus, there is usually no benefit in using odd or even parity, and since this also increases the number of binary bits transmitted for any messages, it decreases throughput.</p>	<i>BnonE</i>	8 bit without parity (default)
		<i>BEuEn</i>	8 bit + even parity
		<i>Bodd</i>	8 bit + odd parity
<i>P94</i>	<p>Configures the Baud rate.</p> <p>Available only P91 is different from OFF.</p> <p>The baud rate of a communications network specifies the speed at which data is transferred between the instrument and the master. As a rule, the baud rate should be set as high as possible to allow maximum throughput. This will depend to some extent on the installation and the amount of electrical noise the communications link is subject to, but the instruments are capable of reliably operating at 19,200 baud under normal circumstances and assuming correct line termination.</p> <p>Although the baud rate is an important factor, when calculating the speed of communications in a system it is often the 'latency' between a message being sent and a reply being started that dominates the speed of the network. This is the amount of time the instrument requires on receiving a request before being able to reply.</p> <p>For example, if a message consists of 10 characters (transmitted in 10msec at 9600 Baud) and the reply consists of 10 characters, then the transmission time would be 20 msec. However, if the latency is 20msec, then the transmission time has become 40msec. Latency is typically higher for commands that write to a parameter than those that read, and will vary to some degree depending on what operation is being performed by the instrument at the time the request is received and the number of variables included in a block read or write. As a rule, latency for single value operations will be between 5 and 20 msec, meaning a turnaround time of about 25-40msec. This compares very favourably with competing devices, which can often take as much as 200msec to turn around communications transactions.</p> <p>If throughput is a problem, consider replacing single parameter transactions with Modbus block transactions, and increase the baud rate to the maximum reliable value in the installation</p>	<i>600</i>	600 bps
		<i>1200</i>	1200 bps
		<i>2400</i>	2400 bps
		<i>4800</i>	4800 bps
		<i>9600</i>	9600 bps
		<i>19200</i>	19200 bps (default)

5.3.13 Pass codes

Pass codes are required to enter both Operator Level 2 and Configuration Level. They are set to default values during manufacture but they can be re-configured using P98 and P99.

Code	Description	Range	
P98	<p>Configures the Level 2 pass code.</p> <p>The pass code required to enter Level 2 can be set in the range 0 to 9999.</p> <p>In the case of level 2 pass code being set to 0, it will not be necessary to enter a pass code to access level 2 and the controller will enter level 2 directly.</p>	0	No pass code is necessary to enter level 2.
		1 to 9999	Default 2
P99	<p>Configures the Configuration level pass code.</p> <p>The pass code required to enter Configuration Level can be set in the range 0 to 9999.</p> <p>In the case of the configuration level pass code being set to 0, it will not be necessary to enter a pass code to access configuration level and the controller will enter CONF directly.</p>	0	No pass code is necessary to enter configuration level.
		1 to 9999	Default 4

5.3.14 Recovery Point

Recovery Point is a way to initialize all parameter values to factory default values stored in read only memory. This can act as a very useful 'Undo' feature.

rEcL	Scroll to rEcL to select Recovery point .		<p>To Restore the Factory Default Settings</p> <p>Select rEcL</p> <p>Press  to select and to move on to the next parameter (in this case to the beginning of the CONF list).</p>
	nOnE	Do nothing (default). The current settings will be used.	
	FRct	Load and restore the factory default settings. The configuration and parameter values loaded during manufacture may be restored.	

6. Digital Communications

Digital Communications (or 'comms' for short) allows the instrument to communicate with a PC or a networked computer system. The pc may be running a SCADA package or iTools software which is a free downloadable package available from www.eurotherm.co.uk and is used (in some instruments for configuration purposes) or for setting and cloning parameters.

This product conforms to Modbus/Jbus RTU protocol a full description of which can be found on www.modbus.org.

One optional EIA485 port on terminals 60, 61 and 62 may be ordered with the following specification:-

Electrical interface	Optional, EIA485 type, opto-isolated.	
Protocol type	Modbus/Jbus (RTU mode).	Configured by 'P' code P92
Type of parameters	Run-time and configuration. Both are available by serial link.	
Configuration software	Through a dedicated PC software application package.	
Device address	From 1 to 255. Note: The device physical interface can only support up to 31 devices for each segment. Use multiple segments for more of 31 devices.	Configured by 'P' code P91
Baud rate	600 up to 19200 baud.	Configured by 'P' code P94
Format	1 start bit, 8 bit with/without parity, 1 stop bit	Configured by 'P' code P93
Parity	Even/Odd.	

Each parameter has its own unique Modbus address. A list of the most commonly used parameters is given in Appendix A.

6.1 EIA485 Field Communications Port

To use EIA485, buffer the EIA232 port of the PC with a suitable EIA232/EIA485 converter. The Eurotherm KD485 Communications Adapter unit is recommended for this purpose. The use of a EIA485 board built into the computer is not recommended since this board may not be isolated, which may cause noise problems, and the RX terminals may not be biased correctly for this application.

To construct a cable for EIA485 operation use a screened cable with one (EIA485) twisted pair plus a separate core for common. Although common or screen connections are not necessary, their use will significantly improve noise immunity and their use is recommended in a factory environment.

6.2 Modbus/JBus Protocol

A description of the use of Modbus or JBus protocol is given in the Communication Handbook part number HA026230 which may be downloaded from www.eurotherm.co.uk.

This should be used in conjunction with the list of parameter addresses given in section 9.

The user should also be aware of the following:-



Warning

In common with most instruments in its class, the P304 Range uses a non-volatile memory with a limited number of specified writes. Non-volatile memory is used to hold information that must be retained over a power cycle, and typically, this includes setpoint and status information.

Please ensure that parameters which do not require updating on a regular basis (for example, setpoints, alarm trip levels, hysteresis, etc) are only written to when a change in the parameter value occurs. Failure to do this could result in permanent damage to the internal EEPROM.





7. Instrument Calibration

The indicator is calibrated during manufacture using traceable standards for every input and output range. It is, therefore, not necessary to calibrate it when changing ranges. Furthermore, the use of a continuous automatic zero correction of the input ensures that the calibration of the instrument is optimised during normal operation. Also, retro-fitting an optional board does not require the calibration of the added circuit, because the board will be shipped from factory already calibrated.



However, there are certain statutory procedures which require verification and possible re-calibration of the instrument. This section describes the procedure. Do not confuse Instrument Calibration with User Calibration of the pressure transducer as described in section 3.10.

7.1 To Access Calibration Mode

Select Configuration level as stated in section 5.1.

1. Then, when **CONF** is being displayed, press and hold the  button again for about 4 seconds until the **Calo** message is shown.
2. Press the  or  button to select **ICAL**.
3. Press  to confirm and enter the level.

4. The display will show 



5. Press  to scroll through a list of inputs and outputs which may be calibrated (or press  to return to the previous parameter). The list of available calibration parameters is given below:-

Parameter	Circuit	Input/Output Type	Range	Value	Note
PL020	Pressure input	Current	Zero	0mA	
PH020	Pressure input	Current	Full scale	20mA	
P 020	Pressure input	Current	Verify		(1)
PL0 5	Pressure input	Voltage 0/5V	Zero	0V	
PH0 5	Pressure input	Voltage 0/5V	Full scale	5V	
P 0 5	Pressure input	Voltage 0/5V	Verify		(1)
PL0 10	Pressure input	Voltage 0/10V	Zero	0V	
PH0 10	Pressure input	Voltage 0/10V	Full scale	10V	
P 0 10	Pressure input	Voltage 0/10V	Verify		(1)
SL020	Secondary input	Current	Zero	0mA	
SH020	Secondary input	Current	Full scale	20mA	
S 020	Secondary input	Current	Verify		(1)
SL0 5	Secondary input	Voltage	Zero	0V	
SH0 5	Secondary input	Voltage	Full scale	5V	
S 0 5	Secondary input	Voltage	Verify		(1)
SL0 10	Secondary input	Voltage	Zero	0V	
SH0 10	Secondary input	Voltage	Full scale	10V	
S 0 10	Secondary input	Voltage	Verify		(1)
SLtc	Secondary input	Thermocouple	Zero	0mV	
SHtc	Secondary input	Thermocouple	Full scale	50mV	
S tc	Secondary input	Thermocouple	Verify		(1)
S . rJ	Secondary input	Thermocouple	Ref. junction	Ambient temperature	
S . rJ	Secondary input	Thermocouple	Verify	Ambient temperature	
SLrtd	Secondary input	RTD-Pt100	Zero	0 Ohm	
SHrtd	Secondary input	RTD-Pt100	Full scale	320 Ohm	
S rtd	Secondary input	RTD-Pt100	Verify		(1)
SLPt5	Secondary input	RTD-Pt500	Zero	0 Ohm	
SHPt5	Secondary input	RTD-Pt500	Full scale	1600 Ohm	
S Pt5	Secondary input	RTD-Pt500	Verify		(1)

Parameter	Circuit	Input/Output Type	Range	Value	Note
<i>PLCur</i>	Main analogue output OUT1	Current	Zero	-5mA	
<i>PHCur</i>	Main analogue output OUT1	Current	Full scale	25mA	
<i>PLCur</i>	Main analogue output OUT1	Current	Verify		(2)
<i>PLuOL</i>	Main analogue output OUT1	Voltage	Zero	-12.5V	
<i>PHuOL</i>	Main analogue output OUT1	Voltage	Full scale	+12.5V	
<i>PLuOL</i>	Main analogue output OUT1	Voltage	Verify		(2)
<i>SLCur</i>	Secondary analogue output OUT2	Current	Zero	-5mA	
<i>SHCur</i>	Secondary analogue output OUT2	Current	Full scale	25mA	
<i>SLCur</i>	Secondary analogue output OUT2	Current	Verify		(2)
<i>SLuOL</i>	Secondary analogue output OUT2	Voltage	Zero	-12.5V	
<i>SHuOL</i>	Secondary analogue output OUT2	Voltage	Full scale	+12.5V	
<i>SLuOL</i>	Secondary analogue output OUT2	Voltage	Verify		(2)
<i>dEFLt</i>	Load default calibration and code data. Note: If an incorrect calibration is performed an error code may be displayed. A list of error codes is given in section 7.2.		<i>OFF</i>	No action	
			<i>On C</i>	Load default calibration values. Then press  to confirm.	

The value stated in the 'Value' column is the value at which the instrument is calibrated. This is further shown in the examples at the end of this section.

Notes:

- (1) The display values for analogue inputs are scaled from 0 to 25000 counts.
- (2) Use the  /  keys to select a display value from 0 to 10 and to check the linearity of output circuit at 0%, 10%, .. 90% and 100% of full scale value +/- 0.05% of full scale value.



- (3) When the display is showing  it is possible to interrogate a number of functions as follows.

Press the  or  to select:-

- Firmware revision
- Pressure input counts
 - Zero, for the strain gauge input (*P.SG.Lo*)
 - Span, for the strain gauge input (*P.SG.Hi*)
 - Pressure (*P.SG*)
 - Zero, for the linear inputs (*PL, Lo*)
 - Span, for the linear inputs (*PL, Hi*)
 - Current (*P.Q20*)
 - Voltage, 0-10V (*P.Q 10*)
- Secondary input counts
 - Zero, for the strain gauge input (*S.SG.Lo*)
 - Span, for the strain gauge input (*S.SG.Hi*)
 - Pressure (*S.SG*)
 - Zero, for the linear inputs (*SL, Lo*)
 - Span, for the linear inputs (*SL, Hi*)
 - Current (*S.Q20*)
 - Voltage, 0-10V (*S.Q 10*)
 - Thermocouple and RTD (*S.t.C.P.t*)
 - Reference junction (*S.r.J*)
 - Line resistance for RTD (*S.r.L*)
- Line frequency (*FrE*)
- Digital inputs status (*dl GJ n*)
- Minimum power consumption. The display will blank as the instrument is consuming minimum power
- Maximum power consumption. The display will show all segments as the instrument is consuming maximum power

7.2 Error Codes

The following error codes could be displayed:-

Code	Meaning
1	Error during EEPROM access.
3	Wrong zero measure
5	Input calibration error.
6	Wrong reference junction measure.
11	Overload or short-circuit on strain gauge power supply. "+EXC" or "-EXC" unconnected wire for strain gauge input.
13	Wrong span measure
14	Internal I ² C bus communication error with EEPROMs
15	Internal I ² C bus communication error with i/o expanders.
RAM	Failure of RAM circuit. The device needs repair

In the case of differential pressure input, the error message in the "Normal display mode" points out the kind of failure: scroll through the Level 1 list and look at the "PI.VAL" or "SI.VAL" parameters to identify the faulty channel.

When the upper display shows "Err" and the lower display shows a parameter mnemonic code this means that the related parameter is in error status.

In this situation two options are available:

- 1) If the wrong parameter is a run-time or configuration parameter, pressing the ▲ + ▼ push-buttons the instrument will load the default values for all parameters.
- 2) If the wrong parameter is a calibration parameter pressing the SCROLL + PAGE push-buttons will enable the instrument to access run-time parameters; this function is intended only to restore a misplaced parameter's value, then the performances of the instrument are not guaranteed. The user is advised to check the stated calibration or code parameter.

7.3 Example 1: To Calibrate the Thermocouple Input

It is first necessary to calibrate the input as a mV input, then calibrate the cold junction temperature.

7.3.1 Connect a calibrated mV source to the thermocouple input terminals using copper cable.

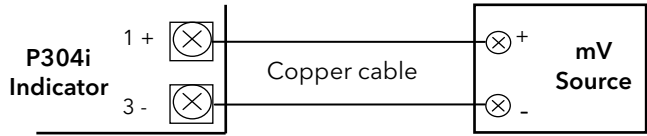

Action	Display	Notes
Press to scroll to the low calibration point for the thermocouple input, <i>SL. tc.</i>		
Set the mV input source to 0.000mV, without thermocouple compensation		Wait a few seconds for the measurement to stabilise
Press / keys to select On Press to enter the low calibration mode		The top display will show a decimal point for a few seconds as the input calibrates to minimum range value.
If successful the display will go to the high calibration point, <i>SH. tc.</i>		If unsuccessful the display will show Err5 - Input calibration out of range. Check the setting of the voltage source.
Set the voltage input source to 50.000mV, uncompensated		Wait a few seconds for the measurement to stabilise
Press / keys to select On Press to enter the high calibration mode		The top display will show a decimal point for a few seconds as the input calibrates to maximum range value (50.000mV).
If successful the display will go to verify, <i>5 . tc.</i>		The upper display shows the number of counts relative to the measured value. the calibration is correct if the number of counts is within 25000 ± 10 counts
Check the linear input calibration by resetting the calibrator to 0.000mV.		The resulting indication should give 0 ± 10 counts.
Check the linearity by setting the calibrator to 25.000mV		The resulting indication should give 12500 ± 20 counts.
Press to select the next calibration parameter		

7.3.2 Connect a temperature calibrator to the thermocouple input terminals using compensating cable.

Note: This calibration covers all types of thermocouple, but ensure that the compensating cable matches the thermocouple type configured in the temperature calibrator - preferably type K. Allow at least 10 minutes to allow the temperature to settle.

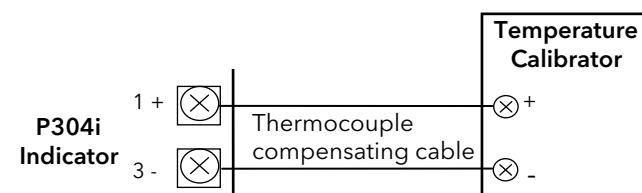

Set the calibrator as a thermocouple simulator and set it to a value close to the ambient temperature in which the instrument is situated.

Action	Display	Notes
Select 5tc (or continue from the previous calibration section)		
Adjust the output of the temperature calibrator until the instrument display shows 0 (+/-5) counts		
Press ← to scroll to the reference junction ambient temperature parameter, 5rj .		The value should read 25.0°C
Using the ▲ / ▼ keys, alter the value until it reads the same value set above in the calibrator.		
Press ← to display 5rj .		The top display will show a decimal point for a few seconds, then show the value of the internal cold junction temperature as set in the previous stage.
If the value is correct press ← to go to the next calibration parameter.		

7.4 Example 2: To Calibrate the Pt100 RTD Input

Connect a calibrated resistance box to the input terminals as shown.

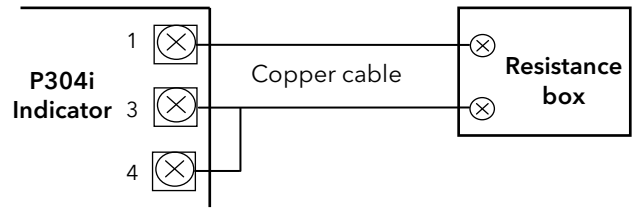

Action	Display	Notes
Press to scroll to the low calibration point for the RTD input, <i>SLrtd</i> .		
Set the resistance box to 0.00 ohm		Wait for a few seconds for the measurement to stabilise.
Press to select On Press to enter the low calibration mode		The top display will show a decimal point for a few seconds as the input calibrates to minimum range value.
If successful the display will go to the high calibration point, <i>SHrtd</i> .		If unsuccessful the display will show Err5 - Input calibration out of range. Check the setting of the resistance box.
Set the resistance box to 320.00 ohm		Wait a few seconds for the measurement to stabilise
Press to select On Press to enter the high calibration mode		The top display will show a decimal point for a few seconds as the input calibrates to maximum range value (320.00 ohm).
If successful the display will go to verify, <i>Srtd</i> .		The upper display shows the number of counts relative to the measured value. The calibration is correct if the number of counts is within 25000 ± 10 counts
Check the linear input calibration by resetting the resistance box to 0.00ohm		The resulting indication should give 0 ± 10 counts.
Check the linearity by setting the resistance box to 160.00ohm.		The resulting indication should give 12500 ± 20 counts.
Press to select the next calibration parameter		

7.5 Example 3: To Calibrate the Pt500 RTD Input

Connect a calibrated resistance box to the input terminals as shown.

The procedure is the same as in the previous example but uses different parameters and resistance settings as described below:

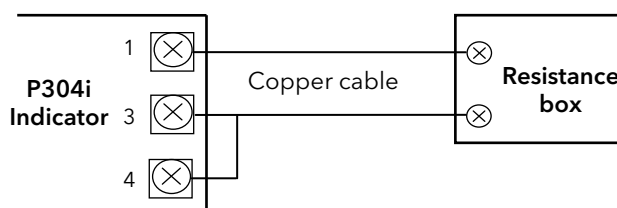

Action	Display	Notes
Press to scroll to the low calibration point for the RTD input, <i>SL.Pt5</i> .		
Set the resistance box to 0.00 ohm		Wait for a few seconds for the measurement to stabilise.
Press keys to select On Press to enter the low calibration mode		The top display will show a decimal point for a few seconds as the input calibrates to minimum range value.
If successful the display will go to the high calibration point, <i>SH.Pt5</i> .		If unsuccessful the display will show Err5 - Input calibration out of range. Check the setting of the resistance box.
Set the resistance box to 1600.00 ohm		Wait a few seconds for the measurement to stabilise
Press keys to select On Press to enter the high calibration mode		The top display will show a decimal point for a few seconds as the input calibrates to maximum range value (1600.00 ohm).
If successful the display will go to verify, <i>5 Pt5</i> .		The upper display shows the number of counts relative to the measured value. The calibration is correct if the number of counts is within 25000 ± 10 counts
Check the linear input calibration by resetting the resistance box to 0.00ohm		The resulting indication should give 0 ± 10 counts.
Check the linearity by setting the resistance box to 800.00ohm.		The resulting indication should give 12500 ± 20 counts.
Press to select the next calibration parameter		

7.6 Example 4: To Calibrate the 0-10V Main Input

Connect a calibrated voltage source the main input terminals as shown.

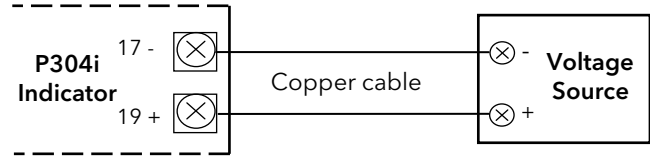

Action	Display	Notes
Press to scroll to the low calibration point for the 0-10V main input, <i>PLD 10</i>		
Set the voltage input source to 0.000V		Wait a few seconds for the measurement to stabilise
Press to select On Press to enter the low calibration mode		The top display will show a decimal point for a few seconds as the input calibrates to minimum range value.
If successful the display will go to the high calibration point, <i>PHD 10</i>		If unsuccessful the display will show Err5 - Input calibration out of range. Check the setting of the voltage source.
Set the voltage input source to 10.000V		Wait a few seconds for the measurement to stabilise
Press to select On Press to enter the high calibration mode		The top display will show a decimal point for a few seconds as the input calibrates to maximum range value (10.000V).
If successful the display will go to verify, <i>P .0 10</i>		The upper display shows the number of counts relative to the measured value. the calibration is correct if the number of counts is within 25000 ± 10 counts
Check the linear input by resetting the calibrator to 0.00V		The resulting indication should be 0 ± 10 counts
Check the linearity by setting the calibrator to 5V		The resulting indication should be 12500 ± 20 counts
Press to select the next calibration parameter		

The procedure for calibrating the 0-10V secondary voltage input is the same but uses the parameters:

SLD 10
SHD 10
SHD 10

7.7 Example 5: To Calibrate the 0-5V Main Input

Connect a calibrated voltage source the main input terminals as shown.

The procedure is the same as for the above example but uses different parameters and voltage values.

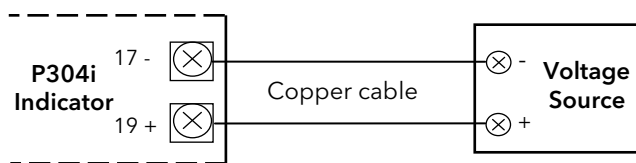

Action	Display	Notes
Press to scroll to the low calibration point for the 0-10V main input, <i>PLD 5</i>		
Set the voltage input source to 0.000V		Wait a few seconds for the measurement to stabilise
Press keys to select On Press to enter the low calibration mode		The top display will show a decimal point for a few seconds as the input calibrates to minimum range value.
If successful the display will go to the high calibration point, <i>PHD 5</i>		If unsuccessful the display will show Err5 - Input calibration out of range. Check the setting of the voltage source.
Set the voltage input source to 5.000V		Wait a few seconds for the measurement to stabilise
Press keys to select On Press to enter the high calibration mode		The top display will blank for a few seconds as the input calibrates to maximum range value (5.000V).
If successful the display will go to verify, <i>P 0 5</i>		The upper display shows the number of counts relative to the measured value. the calibration is correct if the number of counts is within 25000 ± 10 counts
Check the linear input by resetting the calibrator to 0.00V		The resulting indication should be 0 ± 10 counts
Check the linearity by setting the calibrator to 2.5V		The resulting indication should be 12500 ± 20 counts
Press to select the next calibration parameter		

The procedure for calibrating the 0-5V secondary voltage input is the same but uses the parameters:

SLO 5

SHD 5

SHD 5

7.8 Example 6: To Calibrate the 0-20mA Main Input

Connect a calibrated voltage source the main input terminals as shown.

The procedure is the same as for the above example but uses different parameters and voltage values.

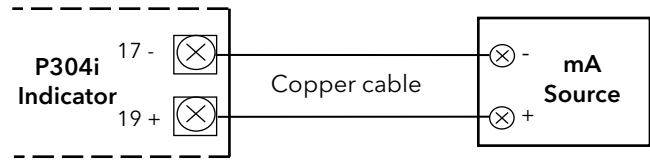

Action	Display	Notes
Press to scroll to the low calibration point for the 0-20mA main input, <i>PL.020</i>		
Set the mA input source to 0.000mA or 0.00mV or 0.000V (even if the minimum range is 4mA).		Wait a few seconds for the measurement to stabilise
Press to select On Press to enter the low calibration mode		The top display will show a decimal point for a few seconds as the input calibrates to the minimum range value.
If successful the display will go to the high calibration point, <i>PH.020</i>		If unsuccessful the display will show Err5 - Input calibration out of range. Check the setting of the current source.
Set the current input source to 20mA		Wait a few seconds for the measurement to stabilise
Press to select On Press to enter the high calibration mode		The top display will blank for a few seconds as the input calibrates to maximum range value (20mA).
If successful the display will go to verify, <i>P .020</i>		The upper display shows the number of counts relative to the measured value. the calibration is correct if the number of counts is within 25000 ± 10 counts
Check the linear input by resetting the calibrator to 0.00mA		The resulting indication should be 0 ± 10 counts
Check the linearity by setting the calibrator to 10.0mA		The resulting indication should be 12500 ± 20 counts
Press to select the next calibration parameter		

The procedure for calibrating the 0-20mA secondary current input is the same but uses the parameters:

SL.020

SH.020

SH.020

7.9 Example 7: To Calibrate the Main Voltage Output (OUT1)

The example is given for 0-10V output.

Connect a calibrated volt meter to the retransmission output terminals 21 and 22.

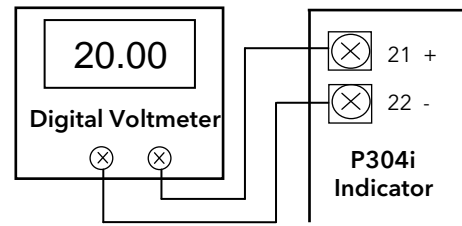

Action	Display	Notes
Press to scroll to the main analogue output low calibration point, $\overline{NL}\mu\text{OL}$.		The upper display should read between 0 and 20000.
Press \blacktriangle / \blacktriangledown keys to adjust the reading on the output meter for $-12.5\text{V} \pm 2\text{mV}$		The number shown in the upper display is an example only. The instrument memorises this value as zero.
Press to scroll to the main analogue output high calibration point, $\overline{NH}\mu\text{OL}$.		The upper display should read between 0 and 20000.
Press \blacktriangle / \blacktriangledown keys to adjust the reading on the output meter for $+12.50\text{V} \pm 2\text{mV}$		The number shown in the upper display is an example only. The instrument memorises this value as full scale.
Press to scroll to the main analogue output verify calibration point, $\overline{V}\mu\text{OL}$		With a reading of 0 the voltmeter should show -12.5Vdc . The voltmeter reading will change by 2.5V for every unit change which is made on the instrument. It is not generally necessary to make these checks.
Check the linear calibration by pressing \blacktriangle / \blacktriangledown keys to modify the value on the upper display from 0 to 10 and check the linearity of the out circuit at 0%, 10%, etc to 100% of full scale value		The maximum error must be $\pm 2\text{mV}$
Press to select the next calibration parameter		

For a current output substitute the voltmeter for a calibrated ammeter. The following parameters apply:

$\overline{NL}\text{CU}$ The low calibration point should read -5mA

$\overline{NH}\text{CU}$ The high calibration point should read $+25\text{mA}$

$\overline{V}\text{CU}$

The secondary analogue output (OUT2) may be calibrated the same as the above procedure. Refer to the table in section 7.1 for the relevant parameters.

To leave calibration level, press and hold until the \overline{GOTO} display is shown and use the \blacktriangledown or \blacktriangle button to select the desired level of operation.

8. CPI (Configuration Port Interface)

In addition to the EIA485 digital communications port, the instrument is provided with an internal port which allows field upgrade of the firmware and also configuration and upload/download of the complete instrument parameter set (cloning function).

Do not use this port for any other purposes.

8.1 CPI Adaptor

A choice of two configuration clips are available from Eurotherm either of which may be ordered as part of the iTools configuration package or as a separate item:

1. USB CPI Clip which may be ordered quoting part number IToolsNONE-USB. This consists of a cable fitted with a USB interface for the pc and a 5-pin clip which connects to the instrument.

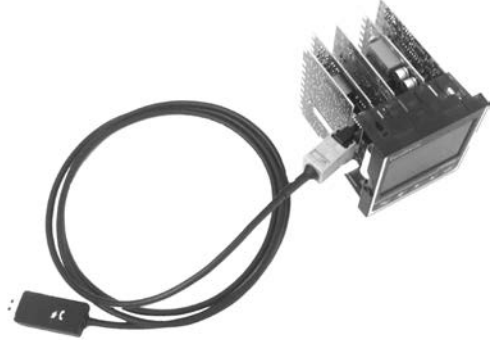

2. An alternative EIA232 9-pin serial port interface clip may be ordered quoting part number IToolsNONE-CK. This consists of a cable fitted with a 9-pin D type connector for the pc serial port, an international power supply (European; US/Japan and UK) and the 5-pin instrument clip.



The 5-pin clip can be connected to the instrument either in or out of its sleeve. It is not necessary to power the instrument since power is supplied through the adaptor.

With the adaptor fitted all functions of the instrument are disabled, and the instrument is put into 'remote' mode. If the instrument is powered up the 'Rem' beacon is lit, but the remainder of the display is blank.

8.2 Firmware Update Procedure

The firmware code is stored in a rewritable Flash memory and it can be updated following the below procedure.

Required tools:

- A PC with serial COM port or with an USB to Serial adapter.
 - A CPI (Configuration Port Interface) adapter as shown in the previous section.
 - The "Flash Magic" PC tool, available for download at the <http://www.flashmagictool.com> URL.
1. Disconnect the indicator unit from power supply. Enable the boot-loader by linking the SH5 "coffee bean" by means of a soldering iron. This is found at the top of the microcontroller (middle) board.
An alternative is to press and hold the PAGE - ▼ - SCROLL keys combination during power-on.
 2. Connect the CPI adapter to the PC and to the indicator/controller device.
 3. Supply power to the indicator/controller unit trough the CPI power supply or USB port or the terminal block, in no case will the display light up.
 4. Download, install and start the "Flash Magic" PC tool, it works on any versions of Windows, except Windows 95. 10Mb of disk space is required.
 5. Select in the "Step 1 - Communications" frame:
 - The COM Port being used.
 - The Baud Rate, maximum 115200 Baud.
 - The Device, LPC2364. Some prototypes are fitted with the LPC2366. "Flash Magic" warns about improper device.
 - The Interface, None (ISP).
 - The Oscillator Freq. (MHz),14.748.
 6. Check the "Erase all Flash+Code Rd Prot" option.
 7. Using the "Browse..." button select the Hex file to download into the device.
 8. In the "Step 4 - Options" frame check the "Verify after programming" option and uncheck the other options.
 9. Click on the "Start" button to launch the procedure. The bottom bar should report in sequence the messages below:
 - Attempting to connect...
 - Erasing device...
 - Programming device (0x00000000)...
 - Verifying (0x00000000)...
 - Finished
 10. Disconnect the CPI adapter.
 11. Disable the boot-loader by removing the short-circuit on the SH5 "coffee bean".
 12. Reconnect the indicator unit to the power supply and check the result of the firmware update. Possible error messages on the display may happen due to inconsistency between the updated firmware and the data stored in the non-volatile (EEPROM) memory.

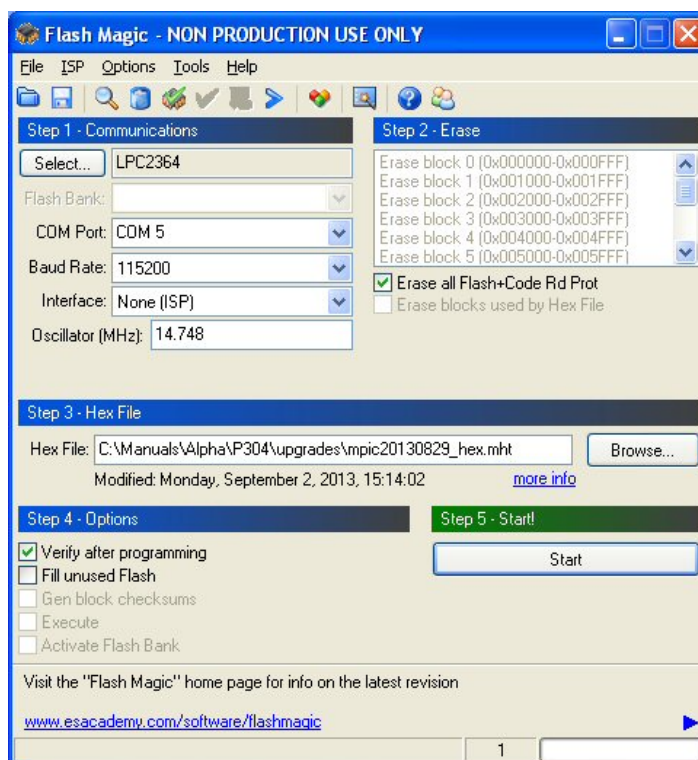

Troubleshooting

In some rare cases, the "Flash Magic" prompts the "Unable to communicate.... Try raising or lowering the baud rate" message. Retry setting the baud rate to 57600.

9. Appendix A Modbus and Jbus Addresses

9.1 Multiplier and Decimal figures

Some parameters have a related variable stated as "multiplier"; this system allows the limits of +/- 32767 counts to be overcome.

Example: the measured value 80000 is sent as 1600 and a multiplier of 50.

The host must know the multiplier before writing a value.

The multiplier is chosen by the device (unless pressure input full scale value selection).

Similarly some parameters have a related variable stated as "decimal figures" indicating the decimal point position.

9.2 S2K IEEE floating point notation

Some variables are mirrored as a floating point value in the MODBUS IEEE region at 8000h. In this case the address is multiplied by 2 and offset by 8000h. For example, 'Alarm 1 Threshold address of 1105 is IEEE 34978.

Two Modbus registers are read and interpreted as a single IEEE value.

When a variable supports this notation the MODBUS IEEE address is indicated in the Variable Address column.

9.3 Level 1 and Level 2 Parameters

Mnem.	Parameter	Modbus	Jbus	Range
	Local/remote device status	218	219	0 = local 1 = remote At power up, each slave is in local mode. In order to enable a slave to be controlled from the master, it is necessary to set the local/remote device status. For a slave to remain in remote status, it is sufficient to detect line activity. If there is no line activity for more than 3 seconds every slave will automatically return to local mode. If remote is issued via CPI port the slave doesn't automatically return to local mode. Local mode: The communication between master and slave is limited to transferring data from slave to master without the possibility of modifying any parameter from the master itself (with the exception of the local/remote device status and the error handling variables). Therefore, from the local keyboard, parameters can be displayed and modified. Remote mode: The instrument parameters can be modified by the master. Therefore, from the instrument front, the parameters can only be displayed but not modified.
AL MAS	ALARMS MASK RESET	1101	1102	1 = restore the alarm mask The write of '0' to this address is allowed and has no effect.
AL 1	ALARM 1 THRESHOLD	1105	1106	See also the example in section 9.2 above.
	Decimal figures assigned to alarm 1 threshold	1106	1107	
	Multiplier assigned to alarm 1 threshold	1107	1108	
A 1HS	ALARM 1 HYSTERESIS	1406	1407	
AL 2	ALARM 2 THRESHOLD	1108	1109	
A 2HS	ALARM 2 HYSTERESIS	1408	1409	
AL 3	ALARM 3 THRESHOLD	1111	1112	
A 3HS	ALARM 3 HYSTERESIS	1410	1411	
P_i μAL	PRIMARY PRESSURE INPUT VALUE	1114	1115	Note: When an error is detected on measure the "data" field contains one of these error codes: 30002 (7532h): Open 30003 (7533h): Wrong zero measure 30011 (753Bh): Overload or short-circuit on strain gage power supply 30013 (753Dh): Wrong span measure
S_i μAL	SECONARY PRESSURE INPUT VALUE	1116	1117	Note: 30002 (7532h): Open

Mnem.	Parameter	Modbus	Jbus	Range
				30003 (7533h): Wrong zero measure 30011 (753Bh): Overload or short-circuit on strain gage power supply 30013 (753Dh): Wrong span measure
LoZ	ZERO CALIBRATION	1200	1201	1 = start the zero calibration; allow at least 5 seconds to complete the calibration procedure. The progress and the result of calibration is available in the "Input calibration status" variable. 2 = restore the default value for zero calibration. The write of '0' to this address is allowed and has no effect. Note: Writing 1 is possible only in normal operative mode
LoZL	ZERO CALIBRATION FOR SECONDARY INPUT	1226	1227	1 = start the zero calibration; allow at least 5 seconds to complete the calibration procedure. The progress and the result of calibration is available in the "Input calibration status" variable. 2 = restore the default value for zero calibration The write of '0' to this address is allowed and has no effect. Note: Writing 1 is possible only in normal operative mode
HiZ	SPAN CALIBRATION	1201	1202	1 = start the span calibration (see "Zero calibration" variable) 2 = restore the default value for span calibration The write of '0' to this address is allowed and has no effect. Note: Writing 1 is possible only in normal operative mode
HiZL	SPAN CALIBRATION FOR SECONDARY INPUT	1227	1228	1 = start the span calibration (see "Zero calibration" variable) 2 = restore the default value for span calibration The write of '0' to this address is allowed and has no effect. Note: Writing 1 is possible only in normal operative mode
A1FL	ALARM 1 FILTER	1217	1218	0 = 0 s (no filter)
A2FL	ALARM 2 FILTER	1218	1219	1 = 0.4 s
A3FL	ALARM 3 FILTER	1219	1220	2 = 1 s
roFL	RETRANSMISSION OUTPUT FILTER	1222	1223	3 = 2 s 4 = 3 s 5 = 4 s 6 = 5 s

9.4 Configuration Parameters

Code	Description	Modbus	Jbus	Range		
P1	PRESSURE INPUT SELECTION	1500	1501	0 = strain gage 1 = 0-20 mA 2 = 4-20 mA 3 = 0-5 V 4 = 0-10 V		
P2	PRESSURE INPUT ENGINEERING UNIT	1339	1340	Off kg/cm ² psi bar MPa		
P3	PRESSURE INPUT FULL SCALE VALUE	1301	1302	The permissible write value depends from the previously sent pressure input multiplier:		
				Multiplier	Full scale value	Permissible variable value
				1	10.. 4000	10..4000
				2	4002.. 8000	2001..4000
				5	8005..20000	1601..4000
				10	20010..40000	2001..4000
				20	40020..80000	2001..4000
				50	80050..99950	1601..1999
P4	PRESSURE INPUT LOW SCALE VALUE	1302	1303			
P5	PRESSURE INPUT DECIMAL POINT POSITION	1303	1304	Decimal figures assigned to pressure input full scale value, displayed input variable, instantaneous input variable, operative set point value, peak value, deviation value, set point, remote set point input range low, remote set point input range high, retransmission output range low, retransmission output range high, set point limit low, set point limit high, set point ramp, secondary pressure input full scale value, primary input pressure value, secondary input pressure value.		
P6	PRESSURE INPUT FAIL SAFE	1403	1404	0 = high 1 = low		
P7	SHUNT CALIBRATION	1400	1401	0 = shunt calibration disabled 1 = shunt calibration enabled		
P8	SHUNT VALUE	1401	1402			
P9	PRESSURE INPUT DISPLAY UPDATE TIME	1426	1427	0 = 0.050 s 1 = 0.100 s 2 = 0.250 s 3 = 0.400 s		
P11	SECONDARY INPUT SELECTION	1502	1503	0 = input disabled 1 = t/c 2 = RTD 3 = 0-20 mA 4 = 4-20 mA 5 = 0-5 V 6 = 0-10 V 7 = strain gauge		
P12	SECONDARY INPUT FUNCTION	1508	1509	0 = temperature input 1 = second sensor for differential pressure measurement		
P13	TEMPERATURE (SECONDARY) INPUT THERMOCOUPLE TYPE	1306	1307	0 = J 1 = K 2 = L 3 = N 4 = E 5 = T		
P14	TEMPERATURE (SECONDARY) INPUT RTD TYPE	1342	1343	0 = Pt100 1 = Pt500		

P304i Indicator User Manual

Code	Description	Modbus	Jbus	Range
P15	ENGINEERING UNIT FOR TEMPERATURE (SECONDARY) INPUT	1307	1308	0 - Celcius 1 = Fahrenheit
P16	TEMPERATURE (SECONDARY) INPUT RANGE LOW	1308	1309	
P17	TEMPERATURE (SECONDARY) INPUT RANGE HIGH	1309	1310	
P19	SECONDARY INPUT FULL SCALE VALUE	1340	1341	
P20	SECONDARY INPUT LOW SCALE VALUE	1341	1342	
P21	SECONDARY INPUT FAIL SAFE	1405	1406	0 = high 1 = low
P24	SECONDARY INPUT SAMPLE TIME	1427	1428	0 = 0.050 s 1 = 0.100 s 2 = 0.250 s 3 = 0.400 s
P31	MAIN ANALOG OUTPUT SELECTION	1505	1506	1 = 0/20 mA 2 = 4/20 mA 3 = 0/10 V 4 = -10/10 V 5 = 0/5 V
P32	MAIN ANALOG OUTPUT LINK	1317	1318	0 = the output is linked to the pressure input 1 = the output is linked to the temperature input
P33	MAIN ANALOG OUTPUT RANGE LOW	1318	1319	
P34	MAIN ANALOG OUTPUT RANGE HIGH	1319	1320	
P51	SECONDARY ANALOG OUTPUT SELECTION	1506	1507	0 = output disabled 1 = 0/20 mA 2 = 4/20 mA 3 = 0/10 V 4 = -10/10 V 5 = 0/5 V
P52	SECONDARY ANALOG OUTPUT LINK	1322	1323	0 = the output is linked to the pressure input 1 = the output is linked to the temperature input
P53	SECONDARY ANALOG OUTPUT RANGE LOW	1323	1324	
P54	SECONDARY ANALOG OUTPUT RANGE HIGH	1324	1325	
P61	ALARM 1 INPUT CHANNEL LINK	1311	1312	0 = alarm disabled 1 = pressure alarm 2 = temperature alarm
P62	ALARM 1 TYPE	1312	1313	0 = high alarm 1 = low alarm 2 = low alarm with mask at start-up
P63	ALARM 1 RESET MODE	1407	1408	0 = automatic reset 1 = manual reset
P64	ALARM 1 FAILSAFE MODE	1423	1424	0: failsafe mode 1: non-failsafe mode
P65	ALARM 2 INPUT CHANNEL LINK	1313	1314	As P61
P66	ALARM 2 TYPE	1314	1315	As P62
P67	ALARM 2 RESET MODE	1409	1410	As P63
P68	ALARM 2 FAILSAFE MODE	1424	1425	As P64
P69	ALARM 3 INPUT CHANNEL LINK	1315	1316	As P61

Code	Description	Modbus	Jbus	Range
P70	ALARM 3 TYPE	1316	1317	As P62
P71	ALARM 3 RESET MODE	1411	1412	As P63
P72	ALARM 3 FAILSAFE MODE	1425	1426	As P64
P81	LOGIC INPUT CONFIGURATION This parameter configure the logic input on terminals 23 and 24	1413	1414	0 = input disabled 1 = alarm reset 2 = peak reset 3 = alarm and peak reset 4 = zero calibration 5 = zero calibration, alarm and peak reset
P82	LOGIC INPUT STATUS	1414	1415	0 = input active when contact is closed 1 = input active when contact is open
P83	PEAK DETECTION	1415	1416	0 = disabled 1 = peak high 2 = peak low
P84	LINE FREQUENCY	1422	1423	0 = 50 Hz 1 = 60 Hz 2 = Auto
P85	LINE FREQUENCY READOUT	1428	1429	0 = 50 Hz 1 = 60 Hz 2 = Undefined line frequency: default 50Hz 3 = Undefined line frequency: default 60Hz
P91	SERIAL COMMUNICATION INTERFACE ADDRESS	1335	1336	0 = serial communication interface disabled 1..255 = serial communication interface address Note: The changes related to serial communication interface parameters will be effective after the end of the reply's transmission.
P92	PROTOCOL TYPE	1336	1337	0 = Modbus 1 = Jbus
P93	COMMUNICATION TYPE	1337	1338	0 = 8 bit 1 = 8 bit + even parity bit 2 = 8 bit + odd parity bit
P94	COMMUNICATION BAUD RATE	1338	1339	0 = 600 baud 1 = 1200 baud 2 = 2400 baud 3 = 4800 baud 4 = 9600 baud 5 = 19200 baud
P98	LEVEL 2 PASS CODE	2003	2004	
P99	CONFIGURATION PASS CODE	2004	2005	
rECL	RECOVERY POINT	2100	2101	

9.5 Other Parameters

Code	Description	Modbus	Jbus	Range
	Alarm 1 Status	1008	1009	0: no alarm condition 1: alarm condition
	Alarm 2 Status	1009	1011	
	Alarm 3 Status	1011	1012	
	Displayed input variable (PV)	1000	1001	When an error is detected on measure the "data" field contains one of these error codes: 30002 (7532h): Open 30003 (7533h): Wrong zero measure 30011 (753Bh): Overload or short-circuit on strain gage power supply 30013 (753Dh): Wrong span measure
	Instantaneous input variable	1001	1002	
	Primary input pressure value	1114	1115	
	Secondary input pressure value	1115	1116	
	Alarm and peak reset	2101	2102	1 = alarm reset 2 = peak reset 3 = alarm and peak reset The write of '0' to this address is allowed and has no effect.
	Manual/auto start-up	1334	1335	0 = start-up in automatic mode 1 = start-up in manual mode
	Peak Value	1002	1003	When an error is detected on measure the "data" field contains one of these error codes: 30002 (7532h): Open
	Temperature Value	1003	1004	When an error is detected on measure the "data" field contains one of these error codes: 30002 (7532h): Open 30003 (7533h): Wrong zero measure 30006 (7536h): Wrong reference junction measure

10. Appendix B TECHNICAL SPECIFICATION

General

Environmental performance

Temperature limits	Operation: 0 to 50°C (32 to 122°F), Storage: -20 to 70°C (-4 to 158°F)
Humidity limits	Max 85% non-condensing Storage: RH: 5 to 90% non-condensing
Altitude	<2000 metres (6562ft).
Atmospheres	Not suitable for use in explosive or corrosive atmospheres.

Electromagnetic compatibility (EMC)

Emissions and immunity	EN61326-1 Suitable for light industrial as well as heavy industrial environments.
------------------------	---

Electrical safety

EN61010	Installation category II; Pollution degree 2
Installation category II	The rated impulse voltage on nominal 230V supply is 2500V
Pollution degree 2	Normally only non conductive pollution occurs. Occasionally, however, a temporary conductivity caused by condensation may be expected.

Physical

Case	PC colour black, self-extinguishing degree V0 according to UL94.
Dimensions	DIN 43700 96x96mm
Panel mounting	1/4 DIN
Weight	650 grams
Panel cut-out	92 x 92mm
Panel depth	128 mm
Rear terminals	Screw terminals with safety cover

Keypad and Display

Keypad	Five pushbuttons membrane
Display	LED
Upper digits	Green colour, 5 numeric digits, 7 segments with decimal point, 13.3 mm high
Lower digits	Amber colour, 5 numeric digits, 7 segments with decimal point, 10.7 mm high
Bar graph	Green colour, 35 segment with 3% resolution. Display continuous to indicate the measured variable (0-100% full scale). Alarm set point values displayed. First segment blinks for pressure lower than zero. Last segment blinks for pressure greater than full scale value.
Status beacons	Units, outputs, alarms, active setpoint

Approvals

Agency	cUL
Self certification	CE

Power Supply requirements

High voltage	100 to 230Vac, +/-15% 50 / 60Hz
Low voltage	24Vac, (14 to 32Vac) 50 / 60Hz 24Vdc, (14 to 32Vdc) ±5% ripple voltage,
Power consumption	22VA max at 50Hz, 27VA max at 60Hz. 18VA max at 24Vac; 12W max at 24Vdc.

Transmitter Power Supply (TPSU)

Isolation	isolated from inputs and outputs
Output Voltage	24Vdc, +/-2%; 1.5W for two or four wire transmitters (optional).

Primary Input

Primary input	keyboard selectable between strain gauge and linear.														
Linear input	selectable 0-5Vdc, 0-10Vdc, 0-20mA, 4-20mA.														
Input impedance	< 10 Ω for linear current input > 165 kΩ for linear voltage input.														
Input protection	open circuit detection for strain gauge (on signal and excitation wires) and 4-20 mA inputs; not available for 0-5Vdc, 0-10Vdc and 0-20mA. Keyboard programmable														
Sampling time	50 ms typical. 50 ms typical is also valid for the differential pressure input.														
Display update time	selectable 50, 100, 250 or 400 ms														
Engineering units	dedicated beacons within the display window.														
Calibration mode	Field calibrations (zero and span) are applicable for both strain gauge and linear input. Field calibration can be deleted and original factory values restored.														
Input resolution	4000 counts.														
	<table border="0"> <thead> <tr> <th>Full scale value</th> <th>Resolution</th> </tr> </thead> <tbody> <tr> <td>10/4000</td> <td>1 count</td> </tr> <tr> <td>4002/8000</td> <td>2 counts</td> </tr> <tr> <td>8005/20000</td> <td>5 counts</td> </tr> <tr> <td>20010/40000</td> <td>10 counts</td> </tr> <tr> <td>40020/80000</td> <td>20 counts</td> </tr> <tr> <td>80050/99950</td> <td>50 counts</td> </tr> </tbody> </table>	Full scale value	Resolution	10/4000	1 count	4002/8000	2 counts	8005/20000	5 counts	20010/40000	10 counts	40020/80000	20 counts	80050/99950	50 counts
Full scale value	Resolution														
10/4000	1 count														
4002/8000	2 counts														
8005/20000	5 counts														
20010/40000	10 counts														
40020/80000	20 counts														
80050/99950	50 counts														
Decimal point:	Settable in any position of the display														

Digital Input

Fixed input. Terminals 23 and 24	One input from contact closure (voltage free). Keyboard programmable for alarm reset, peak reset, alarm and peak reset, zero calibration of the primary input, zero calibration of the primary input + alarm + peak reset. Access to parameters by front keyboard is inhibited while zero calibration is running. The reset functions (peak and alarm) are level-triggered; i.e. reset is active as long as the contact is closed. The zero calibration function is edge-triggered; i.e. calibration is started at contact closure.
----------------------------------	---

Secondary Input		Common mode rejection ratio	> 120 dB @50/60 Hz
Selectable Function	Linear, thermocouple, RTD, strain gauge Temperature in the case of linear, thermocouple or RTD. Second sensor for the measurement of differential pressure in the case of strain gauge or linear.	Normal mode rejection ratio	> 60 dB @50/60 Hz
Linear input	selectable 0-5VDC, 0-10VDC, 0-20mA, 4-20mA.	Zero balance	+/- 25% of full scale (approximately +/- 10mV)
Thermocouple type and range	J -200 800°C -328 1472°F	Reference accuracy	+/- 0.1% fsv +/- 1 digit @ 25 +/- 1 °C and nominal power supply voltage
	K -200 1200°C -328 2192°F	Operating accuracy - temperature drift:	< 200 ppm/K of full span (RJ excluded) for TC input < 300 ppm/K of full span for current, voltage and strain gage input < 400 ppm/K of full span for RTD input < 0.1K/K for reference junction
	L -200 800°C -328 1472°F	Zero and span calibration	For differential input, there is no relation between the calibration of the two single sensors; each input is provided with its own zero and span calibration parameters
	N 0 1300°C 32 2372°F	Wiring caution	analogue input lines cannot exceed 30 metre length or leave the location
	T -200 400°C -328 752°F		
	E -200 600°C -328 1112°F		
RTD type and range	Pt100 -200 600°C -328 1112°F Pt500 -200 600°C -328 1112°F		
Input protection:	open circuit detection for strain gauge (on signal and excitation wires), thermocouple, RTD and 4-20 mA inputs. Not available for 0-10VDC, 0-5VDC and 0-20mA inputs. Up or down scale keyboard programmable.		
Input impedance	> 1 Mohm for thermocouple input < 10 ohm for linear current input > 165 kohm for linear voltage input		
TC line resistance	100 Ohm max.		
Reference junction compensation	from -20 to 60 °C.		
RTD	3 wire		
RTD line compensation	up 20 Ohm/wire for the Pt100 and Pt500 sensors		
Sampling time	temperature input: selectable 100, 200, 500 or 1000 ms. differential pressure: 50 ms typical		
Display update	at each sample		
Input resolution with linear input	4000 counts		
Low/High scale values	For temperature input: settable from -1000 to 3000. For remote set point: settable from 0 to pressure input full scale value with the same resolution and decimal point position as pressure input. For measurement of differential pressure using a second sensor: freely settable, but with the same resolution and decimal point position of the primary pressure input.		
Decimal point	Settable in any position for temperature input		
Analogue Input Common Specification		Alarms	
Strain gauge input	from 340 to 5000 ohm, 1-4 mV/V. Excitation 10V +/- 7%. 5 wire connection. Interfacing 1mV/V sensors could worsen the noise performance	Alarm outputs	3 standard alarms
Input signal	-25/125% of full scale (approximately -10/50mV).	AL1 and AL2 contacts	1 SPDT 2 A max @ 240VAC resistive load
Shunt calibration	with or without shunt resistor (value programmable from 40.0 to 100.0%), the same setting is used for both main and secondary inputs when differential pressure measurement is selected.	AL3 contacts:	1 SPST solder jumper selectable NO/NC 2 A max @ 240VAC resistive load Varistor for spikes protection.
		Contact protection	Each alarm is keyboard programmable for - Pressure / Temperature input - High / Low / Low masked on start up - Auto / Latching reset mode
		Type	
		Excitation type	Keyboard configurable for each alarm: relay coil energized in no alarm condition (failsafe) or relay coil energized in alarm condition (non-failsafe).
		Threshold	From 0 to 110% Full Scale (the threshold may be limited due to the selected full scale value).
		Hysteresis	Keyboard programmable for each alarm; from 0.1% to 10.0% of span or 1 LSD (whichever is greater) for each alarm.
		Filter	Selectable from the following values for each alarm OFF, 0.4, 1, 2, 3, 4, 5 sec.
		Update time	At every input conversion
		Modbus Serial Communications	
		Interface	Optional, EIA-485 type, opto-isolated
		Protocol type	Modbus/Jbus (RTU mode).
		Type of parameters	Run-time and configuration. Both are available by serial link
		Configuration software	Through a dedicated PC software application package
		Device address	From 1 to 255
		Baud rate:	600 up to 19200 baud
		Format	1 start bit, 8 bit with/without parity, 1 stop bit
		Parity	Even/Odd

Analogue Output Channels OUT1 & OUT2

Isolation	Opto-isolated from CPU, input and output circuits
Output function	Keyboard selectable:- Pressure input retransmission Temperature input retransmission
Resolution	0.1% in manual mode, 0.03% in automatic mode
Type of output	Keyboard selectable:- <ul style="list-style-type: none"> ● 0/10 VDC min. load 5 kohm, with under/overrange capability from -2.5 to 12.5 V. ● -10/+10 VDC min. load 5 kohm, with under/overrange capability from -12.5 to 12.5 V. ● 0/5 VDC min. load 5 kohm, with under/overrange capability from -1.25 to 6.25 V. ● 0/20 mA max. load 500 ohm, with under/overrange capability from -5 to 25 mA (max. load 400 ohm over 20 mA). ● 4/20 mA max. load 500 ohm, with under/overrange capability from 0 to 24 mA (max. load 400 ohm over 20 mA).

Analogue Output Common Specification

Resolution	0.1% of output span
Reference accuracy	+/- 0.1% of output span @ 25 +/- 1°C and nominal line voltage
Linearity error	< 0.1% of output span
Output noise	< 0.1% of output span
Scaling	Retransmission low and high limits are selectable from 0 to pressure input full scale value (when the retransmitted variable is pressure) or from low to high temperature limits (when the retransmitted variable is temperature). The two scaling values may be freely selectable within the above range, this allows direct or reverse output type.
Output filter	Selectable: OFF, 0.4, 1, 2, 3, 4, 5 sec.

11.Index

Alarms:	12, 19, 24, 29
ambient temperature	4, 14, 38
Analogue.....	10, 24, 27, 28
Calibration.....	16, 21, 24, 25, 30, 34
Cleaning.....	14
Conductive pollution	14
DC.....	30
Digital communications.....	13, 24, 31
Digital communications:.....	24, 31, 33
Digital Input	11
EIA485	3, 13, 22, 31, 33, 45
Electromagnetic compatibility	14
Electrostatic.....	14
EMC	4, 14
End.....	35
Fuse	7
Grounding.....	14
Humidity.....	4, 14
Input.....	9, 22, 24, 25, 26, 30
Input Type.....	26
Input/Output.....	34
Installation.....	3, 4, 14
Internet Site	
UK.....	4, 13, 33
Isolation Boundaries	6
Latching ears.....	4
Level 1	16, 17, 18
Level 1 Parameters	
ALARM 1 THRESHOLD	17, 18, 19
ALARM 2 THRESHOLD	17, 18, 19
ALARM 3 THRESHOLD	17, 18, 19
ALARMS MASK RESET	17, 18, 20
PRIMARY PRESSURE INPUT VALUE.....	17, 18
SECONDARY PRESSURE INPUT VALUE	17, 18
Level 2 Parameters	
ALARM 1 FILTER	18
ALARM 1 HYSTERESIS	18
ALARM 1 THRESHOLD	17, 18, 19
ALARM 2 FILTER	18
ALARM 2 HYSTERESIS	18
ALARM 2 THRESHOLD	17, 18, 19
ALARM 3 FILTER	18
ALARM 3 HYSTERESIS	18
ALARM 3 THRESHOLD	17, 18, 19
ALARMS MASK RESET	17, 18, 20
DISPLAY FILTER	18
MAIN ANALOGUE OUTPUT FILTER.....	18
PRIMARY PRESSURE INPUT VALUE.....	17, 18
SECONDARY ANALOGUE OUTPUT FILTER.....	18
SECONDARY PRESSURE INPUT VALUE	17, 18
SPAN CALIBRATION.....	18, 21
SPAN CALIBRATION FOR SECONDARY INPUT	18, 21
ZERO CALIBRATION.....	18, 21
ZERO CALIBRATION FOR SECONDARY INPUT	18, 21
Linear.....	52
Logic	14, 30
Manual.....	12, 13, 24
Modbus	3, 13, 31, 33
Mounting.....	4
Open.....	16, 21
Order Code.....	1, 5, 7
Panel	3, 4, 29, 30
Panel retaining clips	4
Personnel	14
Pollution	14
Power Supply.....	7
Recovery.....	24, 32
Recovery Point.....	32
Relay	14, 19, 20, 22, 29
Reset	15, 29, 30
Resistor	21
Retransmission	10
RTD	16, 24, 26, 39, 40
Run	8, 36
Safety	14
Scroll.....	32
Sensor Input.....	8
Spacing.....	4
Start up	15
Terminals.....	6
Thermocouple	9, 24, 26, 34, 37
Transmitter	8, 9
Wire Sizes	6
Wiring	6, 14

EUROTHERM: INTERNATIONAL SALES AND SUPPORT
WWW.EUROTHERM.COM

Contact Information

Eurotherm Head Office
Faraday Close,
Durrington,
Worthing, West Sussex,
BN13 3PL

Sales Enquiries
T +44 (01903) 695888
F 0845 130 9936

General Enquiries
T +44 (01903) 268500
F 0845 265982

Worldwide Offices
www.eurotherm.com/global



Scan for local contacts

Represented by:

Copyright Eurotherm S.r.l. 2014

All rights are strictly reserved. Reproduction, distribution or storage of this document in any manner is prohibited without prior written consent from Eurotherm. Information in this document may change without notice and is intended for guidance only. Eurotherm will accept no responsibility for any losses arising from errors in this document.